



# EPOXY 21

Prodotto per uso strutturale in accordo a NTC 2018  
 Product for structural applications  
 Produit pour applications structurelles  
 Produkt für strukturelle Anwendung



Option 1 - Option 7



Annex E - C2



Post-Installed Rebar

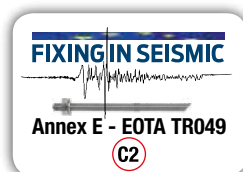

## BCR-900 EPOXY 21

Cartuccia shuttle  
 Shuttle cartridge  
 Cartouche shuttle  
 Shuttlekartusche  
 900 ml  
 cod. 747646



## BCR-470 EPOXY 21

Cartuccia shuttle  
 Shuttle cartridge  
 Cartouche shuttle  
 Shuttlekartusche  
 470 ml  
 cod. 747644



## BCR-265 EPOXY 21

Cartuccia Peeler  
 Peeler cartridge  
 Cartouche Peeler  
 Peelerkartusche  
 265 ml  
 cod. 747625



**STOCCAGGIO E CONSERVAZIONE**  
**STORAGE AND CONSERVATION**  
**STOCKAGE ET CONSERVATION**  
**LAGERUNG UND AUFBEWAHRUNG**



**CARTUCCIA**  
**CARTRIDGE**  
**CARTOUCHE**  
**KARTUSCHE**



24 900 ml  
470 ml

**DURATA (mesi)**  
**EXPIRY (months)**  
**ECHEANCHE (mois)**  
**HALTBARKEIT (Monate)**



16 265 ml

**DURATA (mesi)**  
**EXPIRY (months)**  
**ECHEANCHE (mois)**  
**HALTBARKEIT (Monate)**

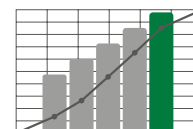



**SCHEDA TECNICA  
TECHNICAL DATA SHEET  
FICHE TECHNIQUE  
TECHNISCHES DATENBLATT**



CONSOLIDAMENTO



STRENGTHENING



Test di valutazione della elettrostaticità, res. superficiale e volumica  
Rapporto > Test report Nr. 247896

**EPOXY 21**

**RESINA EPOSSIDICA PURA / PURE EPOXY RESIN  
RÉSINE EPOXY PURE / EPOXIDHARZ**

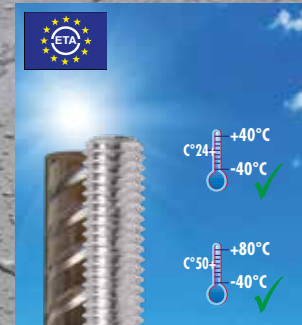
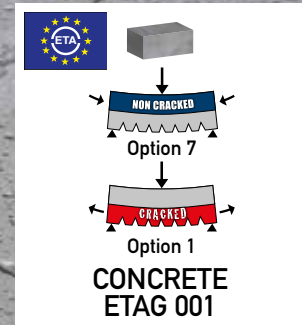

**IT. ANCORANTE CHIMICO BI-COMPONENTE EPOSSIDICO PURO SENZA STIRENE PER CARICHI PESANTI/STRUTTURALI, MARCATO CE E QUALIFICATO ETA PER FISSAGGI IN CALCESTRUZZO.**

ETA (European Technical Assessment) aggiornati in accordo al Regolamento Prodotti da Costruzione 305/2011.

ETA-11/0344: Qualifica in accordo a ETAG-001 parte 5 per calcestruzzo non fessurato, Opzione 7, diametri da M8 a M30. Performance per calcestruzzo fessurato, Opzione 1, per barre M12-M16-M20-M24. Qualifica sismica in accordo EOTA ETAG-001 Annex E. Il prodotto è qualificato in categoria sismica C2 per diametri M16-M20-M24. Il prodotto è omologato per fissaggi con una profondità variabile di ancoraggio, per dare al progettista un'elevata flessibilità. Massima profondità di ancoraggio fino a venti volte il diametro nominale della barra filettata. Le temperature di esercizio certificate sono negli intervalli: -40°C/+40°C (T° max lungo periodo = +24°C), -40°C/+80°C (T° max lungo periodo = +50°C).

ETA-11/0345: Qualifica in accordo a EOTA TR023 per connessioni post-installate in calcestruzzo armato diametri da Ø8 mm a Ø32 mm. Profondità di posa minima in accordo a Eurocodice 2 sia per calcestruzzo fessurato che non fessurato.

Rapporto di resistenza al fuoco per riprese di getto fino ad una resistenza R240. Possibilità di eseguire il foro sia con trapano che con carotatrice (secco/umido). Possibilità di utilizzare profondità di affondamento variabili fino a 2500 mm.

Temperature di esercizio certificate nell' intervallo: -40°C/+80°C (T° max lungo periodo = +50°C). Categoria calcestruzzo CI 0,4 max.

Potete utilizzare il prodotto con calcestruzzo umido o in foro allagato senza raddoppiare i tempi per la messa in carico.

Temperature del supporto (calcestruzzo, muratura ecc...) per l'installazione comprese tra 0°C e +40°C.

Adatto anche per fissaggi su muratura piena e legno.

Qualifica VOC in accordo al Decreto francese nr. 2011-321 ed in conformità alla Norma ISO 16000/EN 16516.

**EN. BI-COMPONENT PURE EPOXY STYRENE FREE CHEMICAL ANCHOR FOR VERY HIGH LOADS, CE MARKED AND ETA ASSESSED FOR USE IN CONCRETE.**

ETA (European Technical Assessments) updated according to the Construction Product Regulation 305/2011.

ETA-11/0344: Assessment according to ETAG-001 part 5 for uncracked concrete, Option 7, for diameters from M8 to M30. Performance for cracked concrete, Option 1, with rod M12-M16-M20-M24. Seismic qualification according to EOTA ETAG-001 Annex E. The product is qualified in seismic category C2 for diameters M12-M16-M20. The product is homologated for fixings with a variable anchorage depth, to give the designer a high degree of flexibility. Maximum anchoring depth up to twenty times the nominal diameter of the threaded rod. Certified service temperatures are in the ranges: -40°C/+40°C (T° max long period = +24°C), -40°C/+80°C (T° max long period = +50°C).

ETA-11/0345: Assessment according to EOTA TR 023 for post-installed rebar connections in reinforced concrete for diameters from Ø8 mm to Ø32 mm. Minimum anchorage depth according to Eurocode 2 in case of uncracked and cracked concrete. Fire resistance test report, up to a maximum of R240. Possibility to drill the hole either with a drill or with a diamond core (dry / wet). Possibility to use variable setting depth up to 2500mm. Certified service temperatures are in the range: -40°C/+80°C (T° max long period = +50°C). Concrete category CI 0,4 max.

You can use the product with wet concrete or in a flooded hole without doubling the time for loading.

Base material temperature (concrete, bricks, etc...) for installation between 0°C and +40°C.

Suitable also for base material like solid masonry and wood.

VOC according to the French Decree nr. 2011-321 and according to ISO 16000/EN 16516.



**GREEN LIFE**

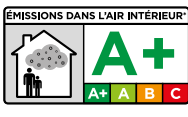

Tiefbauamt Graubünden / Abt. Kunstbauten  
**Liste genehmigter Ankerkleber**



**AIT**  
Asian Institute of Technology

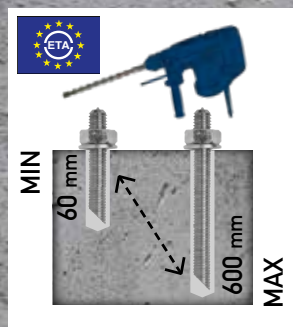

**FR. ANCRAGE CHIMIQUE BI COMPOSANT À BASE DE RÉSINE ÉPOXY PUR SANS STYRÈNE POUR CHARGES TRÈS LOURDES, MARQUAGE CE ET ÉVALUATION ETA POUR ANCRAGE DANS LE BÉTON.**

ETA (Évaluation Technique Européenne) mise à jour conformément au Règlement sur les Produits de Construction 305/2011.

ETA-11/0344 : Évaluation conformément au Guide d'Agrément Technique Européen ETAG-001 partie 5 pour béton non fissuré, Option 7, pour des diamètres de M8 à M30. Performance pour béton fissuré, Option 1, avec barres d'armature M12-M16-M20-M24. Homologation sismique conformément à l'Organisation Européenne pour l'Agrément Technique EOTA ETAG-001 Annex E. Le produit est certifié dans la catégorie sismique C2 pour les diamètres M12-M16-M20. Le produit est homologué pour des scellements avec des profondeurs d'ancrage variables, afin de procurer au concepteur une grande flexibilité. Profondeur d'ancrage maximale jusqu'à vingt fois le diamètre nominal de la tige filetée. Les températures de service certifiées se situent dans l'intervalle suivant : -40°C/+40°C (T° max longue période = +24°C), -40°C/+80°C (T° max longue période = +50°C).

ETA-11/0345 : Évaluation conformément à l'Organisation Européenne pour l'Agrément Technique EOTA TR 023 pour les assemblages de barres d'armature post-installés en béton armé pour des diamètres de Ø8 mm à Ø32 mm. Profondeur d'ancrage minimale selon Eurocode 2 pour le béton non fissuré et fissuré. Rapport de test résistance au feu, jusqu'à un maximum de R240. Possibilité de réaliser le trou avec une perceuse ou une mèche en diamant (sec/humide). Possibilité d'utiliser une profondeur de réglage variable jusqu'à 2500 mm. Les températures de service certifiées se situent dans l'intervalle suivant : -40°C/+80°C (T° max longue période = +50°C. Catégorie de béton Cl 0,4 max.

Il est possible d'utiliser le produit avec du béton fluide ou dans un trou inondé sans doubler le temps de chargement. Température du matériau de construction (béton, briques, etc.) pour une installation entre 0°C et +40°C.

Convient également aux matériaux de construction tels que la maçonnerie pleine et le bois.

COV selon le décret français n° 2011-321 et selon la norme ISO 16000/EN 16516.

**DE. ZWEIKOMPONENTEN EPOXIDHARZ, STYROLFREI, CHEMISCHER ANKER FÜR SEHR HOHE BELASTUNGEN, MIT CE-KENNZEICHNUNG VERSEHEN UND FÜR DEN EINSATZ IN BETON GEPRÜFT.**

ETA (European Technical Assessments) gemäß der Bauprodukteverordnung 305/2011 aktualisiert.

ETA-11/0344: Bewertung gemäß ETAG-001 Teil 5 für ungerissenen Beton, Option 7, für Durchmesser von M8 bis M30. Ausführung für gerissenen Beton, Option 1, mit Gewindestange M12-M16-M20-M24. Seismische Qualifizierung gemäß EOTA ETAG-001, Anhang E. Das Produkt ist in der seismischen Kategorie C2 für die Durchmesser M12-M16-M20 qualifiziert. Das Produkt ist für Befestigungen mit variabler Verankerungstiefe homologiert, um dem Konstrukteur ein hohes Maß an Flexibilität zu ermöglichen. Maximale Verankerungstiefe bis zum Zwanzigfachen des Nenndurchmessers der Gewindestange. Die zertifizierten Betriebstemperaturen liegen in den Bereichen: -40°C/+40°C (Langzeit-T°max = +24°C), -40°C/+80°C (Langzeit-T°max = +50°C).

ETA-11/0345: Bewertung gemäß EOTA TR 023 für nachmontierte Bewehrungsanschlüsse in Stahlbeton für Durchmesser von Ø8 mm bis Ø32 mm. Minimale Verankerungstiefe gemäß Eurocode 2 bei ungerissenerm und gerissenerm Beton. Nach Feuerwiderstandsprüfbericht bis maximal R240. Möglichkeit, das Loch entweder mit einem Bohrer oder mit einem Diamantkern (trocken / nass) zu bohren. Möglichkeit der variablen Einstellungstiefe bis 2500 mm. Die zertifizierten Betriebstemperaturen liegen in den Bereichen: -40°C/+80°C (Langzeit-T° max = + 50 ° C. Betonkategorie Cl 0,4 max.

Sie können das Produkt mit nassem Beton oder in einem gefluteten Loch verwenden, ohne die Belastungszeit zu verdoppeln.

Grundwerkstofftemperatur (Beton, Ziegelsteine usw.) für den Einbau zwischen 0° und + 40°C.

Geeignet auch für Grundmaterial wie Vollmauerwerk, und Holz.

VOC gemäß dem französischen Erlass Nr. 2011-321 und gemäß der Norm ISO 16000 / EN 16516.



# SCHEDA TECNICA TECHNICAL DATA SHEET FICHE TECHNIQUE TECHNISCHES DATENBLATT

## Gamma prodotti | Product's range | Gamme produits | Warenangebot

	CODICE > CODE NUMBER	ARTICOLO > ITEM TYPE > ARTIKEL	DESCRIZIONE > DESCRIPTION DESCRIPTION > BESCHREIBUNG	Nr.
		<b>EPOXY-21</b>		
	<b>747646</b>	<b>BCR 900 EPOXY 21</b>	Cartuccia da > Cartridge of Cartouche de > Kartusche von 900 ml & Mixer	6
	<b>747644</b>	<b>BCR 470 EPOXY 21</b>	Cartuccia da > Cartridge of Cartouche de > Kartusche von 470 ml & Mixer	12
	<b>747625</b>	<b>BCR 265 EPOXY 21</b>	Cartuccia da > Cartridge of Cartouche de > Kartusche von 265 ml & Mixer	20
	<b>747656</b>	<b>BOX 470 EPOXY 21</b>	20 x cartucce, 40 x mixers 20 x cartridges, 40 x mixers 20 x cartouches, 40 x mixers 20 x Kartuschen, 40 x Mischer	1

Secondo mixer > Additional mixer  
Deuxieme mixer > Doppelmischer



CODICE CARTUCCIA > CODE CARTRIDGE  
CODE CARTOUCHE > KARTUSCHE NUMBER  
**000000/2M**

EF3  
EF5  
EF2  
EZZ

## Tempi di posa | Setting times | Temps d'installation | Verlegungszeit



**EPOXY 21**

01	02	03
50°C	7 min	7 h
40 °C	15 min	7 h
30 °C	20 min	12 h
25 °C	30 min	14 h
20 °C	50 min	16 h
15 °C	1 h 10'	22 h
10 °C	1 h 40'	28 h
5 °C	2 h 30'	41 h
0 °C	3 h 20'	54 h

**+5°C**  
Temperatura minima del prodotto per l'applicazione  
Minimum product temperature for application  
Température minimal de la cartouche pour l'application  
Min Kartouchetemperatur für die Anwendung

**ASCIUTTO | DRY | SEC | TROCKENEM**



- 01 Temperatura supporto > Base material temperature > Temperature material de base > Grundmaterial-temperatur
- 02 Tempo di lavorabilità > Open time > Temps de manipulation > Verarbeitungszeit
- 03 Attesa per la messa in carico > Curing time > Temps avant l'application de charge > Bauzeit



# Nr. FIXINGS

NUMERO FISSAGGI | NUMBER OF FIXINGS  
NOMBRE DE FIXATIONS | ANZAHL DER BEFESTIGUNGEN

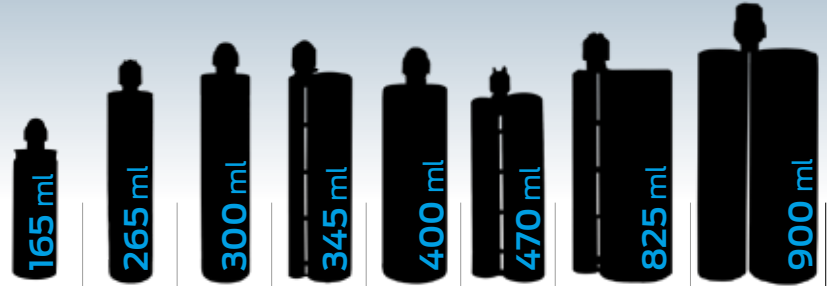

DIAMETRO BARRA ROD DIAMETER DIAMÈTRE DE LA BARRÉ STANGEDURCHMESSER	DIAMETRO FORO HOLE DIAMETER DIAMÈTRE DU TROU BOHRLOCH-DURCHMESSER	PROFONDITÀ EFFETTIVA ANCORAGGIO EFFECTIVE ANCHORAGE DEPTH PROFONDEUR EFFECTIVE D'ANCRAGE EFFEKTIVE VERANKERUNGSTIEFE
---	--	---

	d [mm]	d <sub>0</sub> [mm]	h <sub>e</sub> [mm]	Numero di fissaggi per cartuccia > Numebr of fixing per cartridge > Nombre de fixations por cartouche > Anzahl der Befestigungen für kartusche							
<b>FISSAGGI NEI MATERIALI PIENI &gt; FIXINGS IN SOLID MATERIALS &gt; FIXATIONS DANS MATERIAUX PLEINS &gt; BEFESTIGUNGEN IN VOLLSTEINEN</b>											
	M 8	10	80	± 33,5	± 53,5	± 60,5	± 70,0	± 81,0	± 95,0	± 167,0	± 182,0
	M 10	12	90	± 20,5	± 33,5	± 37,5	± 43,5	± 50,5	± 59,0	± 103,5	± 113,0
	M 12	14	110	± 12,5	± 20,0	± 23,0	± 26,5	± 30,5	± 36,0	± 63,0	± 68,5
	M 14	16	115	± 9,0	± 15,0	± 17,0	± 19,5	± 22,5	± 26,5	± 46,0	± 50,5
	M 16	18	125	± 6,5	± 11,0	± 12,0	± 14,0	± 16,5	± 19,0	± 33,5	± 36,5
	M 18	20	150	± 4,5	± 7,5	± 8,5	± 9,5	± 11,0	± 13,0	± 23,0	± 25,0
	M 20	24	170	± 3,0	± 4,5	± 5,0	± 6,0	± 7,0	± 8,0	± 14,0	± 15,5
	M 22	26	190	± 2,0	± 3,5	± 4,0	± 4,5	± 5,0	± 6,0	± 11,0	± 11,5
	M 24	28	210	± 1,5	± 2,5	± 3,0	± 3,5	± 4,0	± 5,0	± 8,5	± 9,0
	M 27	30	240	± 1,5	± 2,0	± 2,5	± 2,5	± 3,0	± 3,5	± 6,5	± 7,0
	M 30	35	270	± 1,0	± 1,5	± 1,5	± 2,0	± 2,0	± 2,5	± 4,0	± 4,5
	M 33	37	300	± 0,5	± 1,0	± 1,0	± 1,5	± 1,5	± 2,0	± 3,5	± 3,5
M 36	40	330	± 0,5	± 1,0	± 1,0	± 1,0	± 1,5	± 1,5	± 2,5	± 3,0	
M 39	42	360	± 0,5	± 0,75	± 1,0	± 1,0	± 1,0	± 1,5	± 2,0	± 2,5	
<b>FISSAGGI NEI MATERIALI PIENI &gt; FIXINGS IN SOLID MATERIALS &gt; FIXATIONS DANS MATERIAUX PLEINS &gt; BEFESTIGUNGEN IN VOLLSTEINEN</b>											
	Ø 8	12	80	± 23,0	± 37,0	± 42,0	± 48,5	± 56,0	± 66,0	± 116,0	± 126,5
	Ø 10	14	100	± 14,0	± 22,0	± 25,0	± 29,0	± 33,5	± 39,5	± 69,0	± 75,0
	Ø 12	16	120	± 9,0	± 14,0	± 16,0	± 18,5	± 21,5	± 25,0	± 44,5	± 48,5
	Ø 14	18	140	± 6,0	± 9,5	± 11,0	± 12,5	± 14,5	± 17,0	± 30,0	± 33,0
	Ø 16	20	160	± 4,5	± 7,0	± 8,0	± 9,0	± 10,5	± 12,0	± 21,5	± 23,5
	Ø 18	22	180	± 3,0	± 5,0	± 6,0	± 6,5	± 7,5	± 9,0	± 16,0	± 17,5
	Ø 20	25	200	± 2,0	± 3,5	± 4,0	± 4,5	± 5,5	± 6,5	± 11,0	± 12,0
	Ø 22	26	220	± 2,0	± 3,0	± 3,5	± 4,0	± 4,5	± 5,5	± 9,5	± 10,0
	Ø 24	28	240	± 1,5	± 2,5	± 2,5	± 3,0	± 3,5	± 4,0	± 7,5	± 8,0
	Ø 25	30	250	± 1,0	± 2,0	± 2,0	± 2,5	± 3,0	± 3,5	± 6,0	± 6,5
	Ø 26	32	260	± 1,0	± 1,5	± 2,0	± 2,0	± 2,5	± 3,0	± 5,0	± 5,5
	Ø 28	34	280	± 1,0	± 1,5	± 1,5	± 2,0	± 2,0	± 2,5	± 4,5	± 4,5
Ø 30	37	300	± 0,5	± 1,0	± 1,0	± 1,5	± 1,5	± 2,0	± 3,5	± 3,5	
Ø 32	40	320	± 0,5	± 1,0	± 1,0	± 1,0	± 1,5	± 1,5	± 2,5	± 3,0	
<b>FISSAGGI NEI MATERIALI FORATI &gt; FIXINGS IN HOLLOW MATERIALS &gt; FIXATIONS DANS MATERIAUX CREUX &gt; BEFESTIGUNGEN IN LOCHSTEINEN</b>											
	M 8	12	50	± 21,0	± 34,0	± 38,5	± 44,5	± 51,5	± 60,5	± 106,0	± 115,5
	M 8	12	60	± 18,0	± 29,0	± 32,5	± 37,5	± 43,5	± 51,0	± 90,0	± 98,0
	M 8	12	80	± 13,5	± 22,0	± 25,0	± 28,5	± 33,5	± 39,0	± 68,5	± 75,0
	M 10	16	85	± 7,5	± 11,5	± 13,5	± 15,5	± 17,5	± 21,0	± 36,5	± 40,0
	M 10	16	100	± 6,5	± 10,0	± 11,5	± 13,0	± 15,0	± 18,0	± 31,5	± 34,0
	M 10	16	135	± 4,5	± 7,5	± 8,5	± 10,0	± 11,5	± 13,5	± 23,5	± 25,5
	M 10	16	140	± 4,5	± 7,5	± 8,0	± 9,5	± 11,0	± 13,0	± 22,5	± 24,5
	M 14	17	130	± 4,5	± 7,0	± 8,0	± 9,0	± 10,4	± 12,5	± 21,5	± 23,5
	M 12	20	85	± 4,5	± 7,5	± 8,5	± 10,0	± 11,5	± 13,5	± 23,5	± 25,5
	M 16	22	150	± 2,0	± 3,5	± 4,0	± 4,5	± 5,5	± 6,5	± 11,0	± 12,0
	M 16	22	200	± 1,5	± 2,5	± 3,0	± 3,5	± 4,0	± 5,0	± 8,5	± 9,0
	M 20	30	250	± 0,5	± 1,0	± 1,5	± 1,5	± 2,0	± 2,0	± 3,5	± 4,0

> **NOTA:** Il numero di fissaggi sopra specificato è stato determinato conteggiando esclusivamente il volume teorico di prodotto necessario al riempimento del foro (o gabbietta) escluso il volume della barra inserita. Pur essendo incluso nel calcolo teorico uno spreco standard, il reale quantitativo di prodotto potrà differire da questo in funzione della effettiva modalità di posa in opera adottata.

> **WARNING:** The number of fixings above mentioned has been calculated according to the theoretical volume needed to fill the hole (or sleeve) excluded the volume of the inserted metal rod. In the theoretical volume it is included a standard extra quantity but the real quantity of the product may be different than it in function of the real application of the product.

> **NOTE:** Le numéro des fixations sur mentionné a été déterminé en calculant exclusivement le volume théorique de produit nécessaire au remplissage du trou (ou tamis), exclu le volume de la tige filetée. Bien si dans le calcul théorique est incluse une quantité standard de matériel extra, la quantité réelle de produit peut être différente, en fonction des effectives modes d'application du produit.

> **ANMERKUNG:** Die obengenannte Anzahl der Befestigungen wurde nach dem theoretischen Volumen für die Bohrlochfüllung (oder Siebhülse-Füllung) minus dem Volumen der Gewindestange berechnet. Im theoretischen Volumen wird eine Standard-Extra-Menge einkalkuliert, aber die wirkliche Produktmenge kann anders sein, abhängig von der wirklichen Anwendung des Produktes.



**Numero fissaggi | Number of fixings | Nombre de fixations | Anzahl der Befestigungen**

Fissaggi nei materiali pieni > Fixings in solid materials > Fixations dans matériaux pleins > Befestigungen in Vollsteinen



BARRA FILETTATA > THREADED STUD BARRÉ FILETÉE > GEWINDESTANGE	FORO > HOLE TROU > BOHRLOCH	BCR 265	BCR 400	BCR 470	BCR 900
	d <sub>0</sub> [mm] x h <sub>1</sub> [mm]	Nr. Fissaggi > Fixings	Nr. Fissaggi > Fixings	Nr. Fissaggi > Fixings	Nr. Fissaggi > Fixings
M 8	10 x 85	± 50	± 76	± 89	± 170
M 10	12 x 95	± 34	± 51	± 60	± 116
M 12	14 x 115	± 22	± 31	± 36	± 76
M 16	18 x 130	± 14	± 21	± 24	± 47
M 20	24 x 175	± 5	± 7	± 8	± 16
M 24	28 x 215	± 3	± 5	± 6	± 11
M 27	30 x 245	± 3	± 4	± 5	± 10
M 30	35 x 275	± 1,5	± 2,5	± 3	± 5,5

- > **NOTA:** Il numero di fissaggi sopra specificato è stato determinato conteggiando esclusivamente il volume teorico di prodotto necessario al riempimento del foro (o gabbietta) escluso il volume della barra inserita. Pur essendo incluso nel calcolo teorico uno spreco standard, il reale quantitativo di prodotto potrà differire da questo in funzione della effettiva modalità di posa in opera adottata.
- > **WARNING:** The number of fixings above mentioned has been calculated according to the theoretical volume needed to fill the hole (or sleeve) excluded the volume of the inserted metal rod. In the theoretical volume it is included a standard extra quantity but the real quantity of the product may be different than it in function of the real application of the product.
- > **NOTE:** Le numéro des fixations sur mentionné a été déterminé en calculant exclusivement le volume théorique de produit nécessaire au remplissage du trou (ou tamis), exclu le volume de la tige filetée. Bien si dans le calcul théorique est incluse une quantité standard de matériel extra, la quantité réelle de produit peut être différente, en fonction des effectives modes d'application du produit.
- > **ANMERKUNG:** Die obengenannte Anzahl der Befestigungen wurde nach dem theoretischen Volumen für die Bohrlochfüllung (oder Siebhülse-Füllung) minus dem Volumen der Gewindestange berechnet. Im theoretischen Volumen wird eine Standard-Extra-Menge einkalkuliert, aber die wirkliche Produktmenge kann anders sein, abhängig von der wirklichen Anwendung des Produktes.





**Dati installazione | Installation data | Données d'installation | Installationsangaben**

<b>D</b>	Materiale > Material > Matériel > Material
	d [mm] Diametro barra > Rod diameter > Diamètre de la barre > Stangedurchmesser
<b>N</b>	Tipologia di barra > Type of rod > Classe de la barre > Stange-Klasse
	Gabbietta > Plastic sleeve > Tamis > Hülse
<b>E</b>	h <sub>min</sub> [mm] Spessore minimo del supporto > Minimum thickness of base material Épaisseur minimal du matériel de base > Mindestbauteildicke
	d <sub>0</sub> [mm] Diametro foro > Hole diameter > Diamètre du trou > Bohrloch-Durchmesser
<b>G</b>	h <sub>1</sub> [mm] Profondità del foro > Hole depth > Profondeur du trou > Bohrlochtiefe
	h <sub>nom</sub> [mm] Profondità di inserimento > Embedment depth Profondeur d'insertion > Setztiefe
<b>L</b>	h <sub>ef</sub> [mm] Profondità effettiva ancoraggio > Effective anchorage depth Profondeur effective d'ancrage > Effektive Verankerungstiefe

<b>D</b>	S <sub>cr</sub> [mm] Interasse caratteristico > Characteristic spacing Entraxe Caractéristique > Charakteristischerachsabstand
	C <sub>cr</sub> [mm] Distanza dal bordo caratteristica > Characteristic edge distance Distance du bord caractéristique > Charakteristischerandabstand
<b>N</b>	S <sub>min</sub> [mm] Interasse minimo > Minimum allowable spacing Entraxe minimale > Minimaler Achsabstand
	C <sub>min</sub> [mm] Distanza minima dal bordo > Minimum allowable edge distance Distance du bord minimale > Minimaler Randabstand
<b>E</b>	t <sub>fix</sub> [mm] Spessore fissabile > Fixture thickness Épaisseur fixable > Anbauteildicke
	d <sub>f</sub> [mm] Diametro foro spessore fissabile > Diameter of clearance hole in the fixture Diamètre du trou dans l'épaisseur fixable > Bohrloch-Durchmesser im Anbauteil
<b>G</b>	S <sub>w</sub> [mm] Chiave > Key > Clef > Schlüsselweite
	T <sub>inst</sub> [Nm] Coppia di serraggio > Installation torque Couple de serrage > Drehmoment Beim Verankern

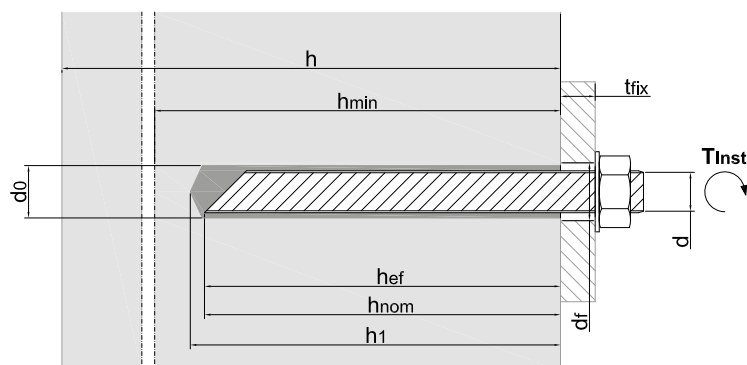

- > **NOTA:** Prima dell'installazione del prodotto consultare la presente sezione e la procedura di installazione completa riportata nelle pagine successive. Si declina ogni responsabilità per l'uso improprio del prodotto.
- > **WARNING:** Before use see this section and the complete procedure of installation reported in the next pages. We assume no liability for the not correct use of the product.
- > **NOTE:** avant l'installation du produit nous vous prions de lire cette section et la procédure d'installation complète que Vous trouvez dans les pages suivantes. Nous n'assurons pas de responsabilité pour une utilisation incorrecte du produit.
- > **ANMERKUNG:** vor der Installation des Produktes bitte diesen Abschnitt und das komplette Installationsverfahren in den folgenden Seiten lesen. Wir übernehmen keine Haftung für die inkorrekte Anwendung des Produktes.



Opzione > Option 1  
M12 ... M24

Opzione > Option 7  
M8 ... M30



M16 ... M24

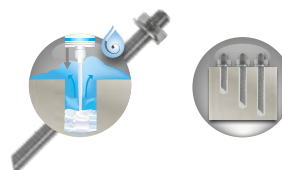

MATERIALE MATERIAL	DIAMETRO BARRA ROD DIAMETER	TIPOLOGIA DI BARRA TYPE OF ROD	SPESSORE MIN. DEL SUPPORTO MIN. THICKNESS BASE MATERIAL			DIAMETRO FORO HOLE DIAMETER	PROFONDITÀ DEL FORO HOLE DEPTH			PROFONDITÀ DI INSERIMENTO EMBEDMENT DEPTH			PROFONDITÀ EFF. ANCORAGGIO EFFECTIVE ANCHORAGE DEPTH			INTERASSE CARATTERISTICO CHARACTERISTIC SPACING			DISTANZA DAL BORDO CARATTERISTICA CHARACTERISTIC EDGE DISTANCE		
			min	med	max		min	med	max	min	med	max	min	med	max	min	med	max	min	med	max
EPOXY 2	d [mm]		h <sub>min</sub> [mm]			d <sub>0</sub> [mm]	h <sub>1</sub> [mm]			h <sub>nom</sub> [mm]			h <sub>ef</sub> [mm]			S <sub>cr,N</sub> [mm]			C <sub>cr,N</sub> [mm]		
M8-M30 Calcestruzzo non fessurato Non cracked Concrete	M8	≥ 5.8 - A4/70	100	110	190	10	65	85	165	60	80	160	60	80	160	180	202	202	90	101	101
	M10	≥ 5.8 - A4/70	100	120	230	12	65	95	205	60	90	200	60	90	200	180	242	242	90	121	121
M12-M24 Calcestruzzo fessurato Cracked Concrete	M12	≥ 5.8 - A4/70	100	140	270	14	75	115	245	70	110	240	70	110	240	210	291	291	105	145	145
	M16	≥ 5.8 - A4/70	116	161	356	18	85	130	325	80	125	320	80	125	320	240	375	388	120	188	194
M16-M24 SEISMIC ANNEX-E C2	M20	≥ 5.8 - A4/70	138	218	448	24	95	175	405	90	170	400	90	170	400	270	462	462	135	231	231
	M24	≥ 5.8 - A4/70	152	266	536	28	100	215	485	96	210	480	96	210	480	288	554	554	144	277	277
CE	M27	≥ 5.8 - A4/70	170	300	600	30	115	245	545	110	240	540	110	240	540	330	624	624	165	312	312
	M30	≥ 5.8 - A4/70	190	340	670	35	125	275	605	120	270	600	120	270	600	360	693	693	180	346	346



# SCHEDA TECNICA TECHNICAL DATA SHEET FICHE TECHNIQUE TECHNISCHES DATENBLATT



Opzione > Option 1

M12 ... M24

Opzione > Option 7

M8 ... M30



M16 ... M24

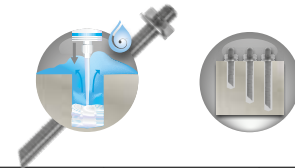

MATERIALE MATERIAL	DIAMETRO BARRA ROD DIAMETER	TIPOLOGIA DI BARRA TYPE OF ROD	INTERASSE MIN. ALLOWABLE SPACING	DISTANZA MIN. DAL BORDO MIN. ALLOWABLE EDGE DISTANCE	SPESS. FISSABILE FIXTURE THICKNESS	DIAMETRO FORO SPESS. FISSABILE DIAMETER OF CLEARANCE HOLE IN THE FIXTURE	CHIAVE KEY	COPIA DI SERRAGGIO INSTALLATION TORQUE
EPOXY 21	d [mm]		S <sub>min</sub> [mm]	C <sub>min</sub> [mm]	t <sub>fix</sub> [mm]	d <sub>f</sub> [mm]	S <sub>w</sub> [mm]	T <sub>inst</sub> [Nm]
M8-M30 Calcestruzzo non fessurato Non cracked Concrete	M8	≥ 5.8 - A4/70	40	40	0 ÷ 1500	9	13	10
	M10	≥ 5.8 - A4/70	50	50	0 ÷ 1500	12	17	20
M12-M24 Calcestruzzo fessurato Cracked Concrete	M12	≥ 5.8 - A4/70	60	60	0 ÷ 1500	14	19	40
	M16	≥ 5.8 - A4/70	80	80	0 ÷ 1500	18	24	80
M16-M24 SEISMIC ANNEX-E C2	M20	≥ 5.8 - A4/70	100	100	0 ÷ 1500	22	30	130
	M24	≥ 5.8 - A4/70	120	120	0 ÷ 1500	26	36	200
	M27	≥ 5.8 - A4/70	135	135	0 ÷ 1500	29	41	270
	M30	≥ 5.8 - A4/70	150	150	0 ÷ 1500	33	46	300

- > Per evitare una possibile rottura per splitting, lo spessore del supporto in calcestruzzo dovrà essere  $h \geq 2h_{ef}$
- > To avoid splitting failure, the thickness of the concrete member shall be  $h \geq 2h_{ef}$
- > Pour éviter une possible rupture par splitting, l'épaisseur du support en béton devrait être  $h \geq 2h_{ef}$
- > Um einen splittingbedingten Bruch zu verhindern, die Dicke der Unterlage aus Beton muss  $h \geq 2h_{ef}$  sein



Ø 8 ... 32 mm

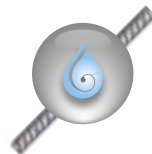

MATERIALE MATERIAL	DIAMETRO BARRA ROD DIAMETER	TIPOLOGIA DI BARRA TYPE OF ROD	DIAMETRO FORO HOLE DIAMETER	LUNGHEZZA DI ANCORAGGIO ANCHORAGE LENGTH (**)			INTERASSE MIN. MIN. ALLOWABLE SPACING	DISTANZA MIN. DAL BORDO MIN. ALLOWABLE EDGE DISTANCE		
				MIN lb	MIN lo	MAX lb		MIN lb	MIN lo	MAX lb
EPOXY 21 C20/25 Calcestruzzo Concrete Beton Beton	d [mm]		d <sub>0</sub> [mm]	l <sub>v</sub> [mm]			S <sub>min</sub> [mm]	C <sub>min</sub> [mm]		
	Ø 8	Rebar (*)	12	115	200	700	40	37	42	72
	Ø 10	Rebar (*)	14	145	200	900	40	39	42	84
	Ø 12	Rebar (*)	16	170	200	1100	48	40	42	96
	Ø 14	Rebar (*)	18	200	210	1300	56	42	43	108
	Ø 16	Rebar (*)	20	230	240	1400	64	44	45	114
	Ø 20	Rebar (*)	25	285	300	1800	80	47	48	138
	Ø 25	Rebar (*)	30	355	375	2200	100	61	63	172
	Ø 28	Rebar (*)	35	400	420	2500	112	64	65	190
Ø 32	Rebar (*)	40	455	480	2500	128	67	69	190	

(\*) Rebar = B450C; BST 500

(\*\*) Lunghezza di ancoraggio in accordo a EC2 e TR023. lb = lunghezza di ancoraggio lo = lunghezza di sovrapposizione  
Anchorage lengths according to EC2 and TR023. lb = anchorage length lo = overlap joint length  
Longueurs d'ancrage en accord avec EC2 et TR023. lb = longueurs d'ancrage lo = longer sousplacées  
Verankerung Länge einigung mit EC2 und TR023. lb = Verankerung Länge lo = Überlagerung Länge





MATERIALE MATERIAL EPOXY 21	DIAMETRO BARRA ROD DIAMETER	TIPOLOGIA DI BARRA TYPE OF ROD	SPESSORE MIN. DEL SUPPORTO MIN. THICKNESS BASE MATERIAL			DIAMETRO FORO HOLE DIAMETER	PROFONDITÀ DEL FORO HOLE DEPTH			PROFONDITÀ DI INSERIMENTO EMBEDMENT DEPTH			PROFONDITÀ EFF. ANCORAGGIO EFFECTIVE ANCHORAGE DEPTH			INTERASSE CARATTERISTICO CHARACTERISTIC SPACING			DISTANZA DAL BORDO CARATTERISTICA CHARACTERISTIC EDGE DISTANCE			INTERASSE MIN. ALLOWABLE SPACING		DISTANZA MIN. DAL BORDO MIN. ALLOWABLE EDGE DISTANCE	
			min	med	max		min	med	max	min	med	max	min	med	max	min	med	max	min	med	max	S <sub>min</sub>	C <sub>min</sub>		
Calcestruzzo non fessurato Non cracked Concrete	Ø 8	Rebar (*)	100	110	190	12	65	85	165	60	80	160	60	80	160	120	160	320	60	80	160	40	40		
	Ø 10	Rebar (*)	100	120	230	14	65	95	205	60	90	200	60	90	200	120	180	400	60	90	200	45	45		
	Ø 12	Rebar (*)	102	142	275	16	75	115	245	70	110	240	70	110	240	140	220	480	70	110	240	55	55		
	Ø 14	Rebar (*)	116	161	316	18	85	130	285	80	125	280	80	125	280	160	250	560	80	125	280	63	63		
	Ø 16	Rebar (*)	120	180	360	20	85	145	325	80	140	320	80	140	320	160	280	640	80	140	320	70	70		
	Ø 20	Rebar (*)	140	220	450	25	95	175	405	90	170	400	90	170	400	180	340	800	90	170	400	85	85		
	Ø 25	Rebar (*)	160	270	560	30	105	215	505	100	210	500	100	210	500	200	420	1000	100	210	500	105	105		
	Ø 28	Rebar (*)	182	340	630	35	117	275	565	112	270	560	112	270	560	224	540	1120	112	270	560	135	135		
Ø 32	Rebar (*)	208	380	720	40	133	305	645	128	300	640	128	300	640	256	600	1280	128	300	640	150	150			

(\*) Rebar = B450C; BST 500

> Parametri d'installazione validi per applicazioni in accordo alla teoria dell'ancoraggio > Installation parameters suitable for application according to the anchors theory  
> Paramètres d'installation en conformité avec la théorie de l'ancrage > Installationsparameter in Übereinstimmung mit der Verankerungstheorie

MATERIALE MATERIAL EPOXY 21	DIAMETRO BARRA ROD DIAMETER	TIPOLOGIA DI BARRA TYPE OF ROD	SPESSORE MIN. DEL SUPPORTO MIN. THICKNESS BASE MATERIAL	DIAMETRO FORO HOLE DIAMETER	PROFONDITÀ DEL FORO HOLE DEPTH	PROFONDITÀ DI INSERIMENTO EMBEDMENT DEPTH	PROFONDITÀ EFF. ANCORAGGIO EFFECTIVE ANCHORAGE DEPTH	INTERASSE CARATTERISTICO CHARACTERISTIC SPACING	DISTANZA DAL BORDO CARATTERISTICA CHARACTERISTIC EDGE DISTANCE	INTERASSE MIN. ALLOWABLE SPACING	DISTANZA MIN. DAL BORDO MIN. ALLOWABLE EDGE DISTANCE	SPESS. FISSABILE MAX FIXTURE THICKNESS	DIAMETRO FORO SPESS. FISSABILE DIAMETER OF CLEARANCE HOLE IN THE FIXTURE	CHIAVE KEY	COPPIA DI SERRAGGIO INSTALLATION TORQUE
Mattone pieno Solid Brick Brique pleine Vollmauerwerk	M8	≥ 4.6 A2-70 A4-70	200	10	85	80	80	160	200	100	100	10	9	13	7
	M10	≥ 4.6 A2-70 A4-70	250	12	90	85	85	200	200	100	100	20	12	17	15
	M12	≥ 4.6 A2-70 A4-70	300	14	100	95	95	240	200	100	100	30	14	19	25
	M16	≥ 4.6 A2-70 A4-70	350	18	130	125	125	320	200	100	100	35	18	24	30

MATERIALE MATERIAL EPOXY 21	DIAMETRO BARRA ROD DIAMETER	TIPOLOGIA DI BARRA TYPE OF ROD	SPESSORE MIN. DEL SUPPORTO MIN. THICKNESS BASE MATERIAL	DIAMETRO FORO HOLE DIAMETER	PROFONDITÀ DEL FORO HOLE DEPTH	PROFONDITÀ DI INSERIMENTO EMBEDMENT DEPTH	PROFONDITÀ EFF. ANCORAGGIO EFFECTIVE ANCHORAGE DEPTH	INTERASSE CARATTERISTICO CHARACTERISTIC SPACING	DISTANZA DAL BORDO CARATTERISTICA CHARACTERISTIC EDGE DISTANCE	INTERASSE MIN. ALLOWABLE SPACING	DISTANZA MIN. DAL BORDO MIN. ALLOWABLE EDGE DISTANCE	SPESS. FISSABILE MAX FIXTURE THICKNESS	DIAMETRO FORO SPESS. FISSABILE DIAMETER OF CLEARANCE HOLE IN THE FIXTURE	CHIAVE KEY	COPPIA DI SERRAGGIO INSTALLATION TORQUE
Legno lamellare Laminated Timber Holz	M8	≥ 4.6 A2-70 A4-70	160	10	85	80	80	100	80	50	50	10	9	13	7
	M10	≥ 4.6 A2-70 A4-70	200	12	105	100	100	125	100	50	50	20	12	17	15
	M12	≥ 4.6 A2-70 A4-70	240	14	125	120	120	150	120	60	60	30	14	19	25
	M16	≥ 4.6 A2-70 A4-70	320	18	165	160	160	200	160	80	80	35	18	24	30



# SCHEDA TECNICA TECHNICAL DATA SHEET FICHE TECHNIQUE TECHNISCHES DATENBLATT

## Dati carico | Load data | Données de charge | Lastdaten

<b>D</b>	$N_{rum}$ [kN]	Carico ultimo medio a trazione > Average ultimate tension load > Charge maximum moyenne de traction Durchschnittliche maximale Zuglast
	$V_{rum}$ [kN]	Carico ultimo medio a taglio > Average ultimate shear load > Charge maximum moyenne de cisaillement Durchschnittliche maximale Querlast
<b>E</b>	$N_{rk}$ [kN]	Carico caratteristico a trazione > Characteristic tension load > Charge caracteristique de traction Charakteristische Zuglast
	$V_{rk}$ [kN]	Carico caratteristico a taglio > Characteristic shear load > Charge caracteristique de cisaillement Charakteristische Querlast
<b>L</b>	$N_{rec}$ [kN]	Carico ammissibile a trazione > Admissible tensile load > Charge admissible de traction > Zulässige Zuglast
	$V_{rec}$ [kN]	Carico ammissibile a taglio > Admissible shear load > Charge admissible de cisaillement > Zulässige Querlast

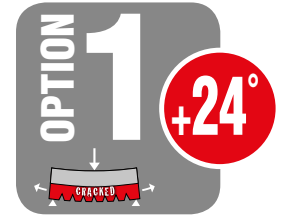

- > Carichi validi per singolo ancorante senza influenza di interasse e distanza dal bordo e  $h \geq 2h_{ef}$  > 1kN = 100 Kg
- > Loads for single anchor with no influence of spacing and edge distance and with  $h \geq 2h_{ef}$  >  $\psi_{sds} = 1,0$
- > Charges valables pour chaque ancrage sans influence d'interaxe et distance du bord et  $h \geq 2h_{ef}$
- > Passende Ringe für den einzelnen Veranker, ohne Achsenabstandseinfluss und des Randabstands und  $h \geq 2h_{ef}$

- > Azione di taglio non diretta verso il bordo > Coefficiente di sicurezza globale incluso > Coefficiente lato carichi utilizzato = 1,4
- > Shear directed away from the edge > General safety factor included > Load increasing safety coefficient used = 1,4
- > Action de cisaillement pas dirigée vers le bord > Coefficient de sécurité generale inclu > Coefficient côté charge utilisé = 1,4
- > Queraktion nicht an den Rand gerichtet > Generelle Sicherheitskoeffizient inbegriffen > Verwendeter Lasterhöhungssicherheitskoeffizient = 1,4

Con foro allagato, riduzione del carico consigliato del 20%  
With flooded hole, reduction of the recommended load of 20%



## MIN Dati di carico con profondità effettiva ancoraggio MINIMA > Load data with MINIMUM effective anchorage depth Donnes de charge avec profondeur efficace d'ancrage MINIMALE > Lastdaten mit MINIMALER effektiven Verankerungstiefe

EPOXY 21 MATERIALE MATERIAL	BARRA ROD	DIAMETRO BARRA ROD DIAMETER	PROFONDITÀ EFF. ANCORAGGIO EFFECTIVE ANCHORAGE DEPTH	CARICO ULTIMO MEDIO A TRAZIONE ULTIMATE TENSION LOAD	CARICO ULTIMO MEDIO A TAGLIO ULTIMATE SHEAR LOAD	CARICO CARATTERISTICO A TRAZIONE CHARACTERISTIC TENSILE LOAD	CARICO CARATTERISTICO A TAGLIO CHARACTERISTIC SHEAR LOAD	CARICO AMMISSIBILE A TRAZIONE ADMISSIBLE TENSILE LOAD	CARICO AMMISSIBILE A TAGLIO ADMISSIBLE SHEAR LOAD
C20/25 Calcestruzzo fessurato Cracked Concrete Beton fissuré Gerissener Beton  EPOXY 21 ≥ 5.8	≥ 5.8	M 12	70	27,8	26,2	20,9	21,9	9,9	12,5
	≥ 5.8	M 16	80	33,9	48,9	25,7	40,8	12,2	19,8
	≥ 5.8	M 20	90	40,5	76,2	30,7	61,5	14,6	29,2
	≥ 5.8	M 24	96	44,6	89,3	33,8	67,7	16,1	32,2

## MED Dati di carico con profondità effettiva ancoraggio MEDIA > Load data with MEDIUM effective anchorage depth Donnes de charge avec profondeur efficace d'ancrage MOYENNE > Lastdaten mit MITTLERER effektiven Verankerungstiefe

EPOXY 21 MATERIALE MATERIAL	BARRA ROD	DIAMETRO BARRA ROD DIAMETER	PROFONDITÀ EFF. ANCORAGGIO EFFECTIVE ANCHORAGE DEPTH	CARICO ULTIMO MEDIO A TRAZIONE ULTIMATE TENSION LOAD	CARICO ULTIMO MEDIO A TAGLIO ULTIMATE SHEAR LOAD	CARICO CARATTERISTICO A TRAZIONE CHARACTERISTIC TENSILE LOAD	CARICO CARATTERISTICO A TAGLIO CHARACTERISTIC SHEAR LOAD	CARICO AMMISSIBILE A TRAZIONE ADMISSIBLE TENSILE LOAD	CARICO AMMISSIBILE A TAGLIO ADMISSIBLE SHEAR LOAD
C20/25 Calcestruzzo fessurato Cracked Concrete Beton fissuré Gerissener Beton  EPOXY 21 ≥ 5.8	≥ 5.8	M 12	110	43,8	26,2	32,9	21,9	15,6	12,5
	≥ 5.8	M 16	125	66,3	48,9	43,1	40,8	20,5	23,3
	≥ 5.8	M 20	170	105,2	76,2	79,8	63,5	38,0	36,2
	≥ 5.8	M 24	210	144,5	110,4	109,5	92,0	52,1	52,5

## MAX Dati di carico con profondità effettiva ancoraggio MASSIMO > Load data with MAXIMUM effective anchorage depth Donnes de charge avec profondeur efficace d'ancrage MAXIMUM > Lastdaten mit MAXIMALER effektiven Verankerungstiefe

EPOXY 21 MATERIALE MATERIAL	BARRA ROD	DIAMETRO BARRA ROD DIAMETER	PROFONDITÀ EFF. ANCORAGGIO EFFECTIVE ANCHORAGE DEPTH	CARICO ULTIMO MEDIO A TRAZIONE ULTIMATE TENSION LOAD	CARICO ULTIMO MEDIO A TAGLIO ULTIMATE SHEAR LOAD	CARICO CARATTERISTICO A TRAZIONE CHARACTERISTIC TENSILE LOAD	CARICO CARATTERISTICO A TAGLIO CHARACTERISTIC SHEAR LOAD	CARICO AMMISSIBILE A TRAZIONE ADMISSIBLE TENSILE LOAD	CARICO AMMISSIBILE A TAGLIO ADMISSIBLE SHEAR LOAD
C20/25 Calcestruzzo fessurato Cracked Concrete Beton fissuré Gerissener Beton  EPOXY 21 8.8	8.8	M 12	240	67,4	40,4	67,4	33,7	32,1	19,2
	8.8	M 16	320	125,0	75,0	110,4	62,5	52,6	35,7
	8.8	M 20	400	203,0	121,8	189,2	101,5	90,1	58,0
	8.8	M 24	480	293,0	175,8	278,0	146,5	132,5	83,7



**Dati carico | Load data | Données de charge | Lastdaten**

<b>D N E G L</b>	<b>N<sub>rum</sub></b> [kN]	Carico ultimo medio a trazione > Average ultimate tension load > Charge maximum moyenne de traction Durchschnittliche maximale Zuglast
	<b>V<sub>rum</sub></b> [kN]	Carico ultimo medio a taglio > Average ultimate shear load > Charge maximum moyenne de cisaillement Durchschnittliche maximale Querlast
	<b>N<sub>rk</sub></b> [kN]	Carico caratteristico a trazione > Characteristic tension load > Charge caractéristique de traction Charakteristische Zuglast
	<b>V<sub>rk</sub></b> [kN]	Carico caratteristico a taglio > Characteristic shear load > Charge caractéristique de cisaillement Charakteristische Querlast
	<b>N<sub>rec</sub></b> [kN]	Carico ammissibile a trazione > Admissible tensile load > Charge admissible de traction > Zulässige Zuglast
	<b>V<sub>rec</sub></b> [kN]	Carico ammissibile a taglio > Admissible shear load > Charge admissible de cisaillement > Zulässige Querlast

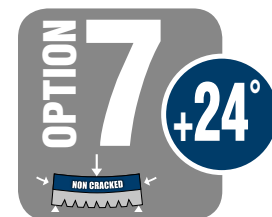

> Carichi validi per singolo ancorante senza influenza di interasse e distanza dal bordo e  $h \geq 2h_{ef}$  > 1kN = 100 Kg  
 > Loads for single anchor with no influence of spacing and edge distance and with  $h \geq 2h_{ef}$  >  $\psi_{fas} = 1,0$   
 > Charges valables pour chaque ancrage sans influence d'interaxe et distance du bord et  $h \geq 2h_{ef}$   
 > Passende Ringe für den einzelnen Veranker, ohne Achsenabstandseinfluss und des Randabstands und  $h \geq 2h_{ef}$

> Azione di taglio non diretta verso il bordo > Coefficiente di sicurezza globale incluso > Coefficiente lato carichi utilizzato = 1,4  
 > Shear directed away from the edge > General safety factor included > Load increasing safety coefficient used = 1,4  
 > Action de cisaillement pas dirigée vers le bord > Coefficient de sécurité générale inclu > Coefficient côté charge utilisé = 1,4  
 > Queraktion nicht an den Rand gerichtet > Generelle Sicherheitskoeffizient inbegriffen > Verwendeter Lasterhöhungssicherheitskoeffizient = 1,4

Con foro allagato, riduzione del carico consigliato del 20%  
 With flooded hole, reduction of the recommended load of 20%

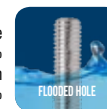

**MIN** Dati di carico con profondità effettiva ancoraggio MINIMA > Load data with MINIMUM effective anchorage depth  
 Données de charge avec profondeur efficace d'ancrage MINIMALE > Lastdaten mit MINIMALER effektiven Verankerungstiefe

MATERIALE MATERIAL	BARRA ROD	DIAMETRO BARRA ROD DIAMETER	PROFONDITÀ EFF. ANCORAGGIO EFFECTIVE ANCHORAGE DEPTH	CARICO ULTIMO MEDIO A TRAZIONE	CARICO ULTIMO MEDIO A TAGLIO	CARICO CARATTERISTICO A TRAZIONE	CARICO CARATTERISTICO A TAGLIO	CARICO AMMISSIBILE A TRAZIONE	CARICO AMMISSIBILE A TAGLIO	
				ULTIMATE TENSION LOAD	ULTIMATE SHEAR LOAD	CHARACTERISTIC TENSILE LOAD	CHARACTERISTIC SHEAR LOAD	ADMISSIBLE TENSILE LOAD	ADMISSIBLE SHEAR LOAD	
EPOXY 21 C20/25 Calcestruzzo non fessurato Non cracked Concrete Béton non fissuré Ungerissener Beton		≥ 5.8	M 8	60	19,0	11,4	17,9	9,5	8,5	5,4
		≥ 5.8	M 10	60	25,4	18,1	21,0	15,1	10,0	8,6
		≥ 5.8	M 12	70	39,4	26,2	29,3	21,9	14,0	12,5
		≥ 5.8	M 16	80	48,3	48,9	36,1	40,8	17,2	23,3
		≥ 5.8	M 20	90	57,6	76,2	43,1	63,5	20,5	36,2
		≥ 5.8	M 24	96	63,4	110,4	47,5	92,0	22,6	45,2
		≥ 5.8	M 27	110	77,8	143,4	58,2	116,5	27,7	55,4
		≥ 5.8	M 30	120	88,7	175,2	66,3	132,8	31,6	63,2



**MED** Dati di carico con profondità effettiva ancoraggio MEDIA > Load data with MEDIUM effective anchorage depth  
 Données de charge avec profondeur efficace d'ancrage MOYENNE > Lastdaten mit MITTLERER effektiven Verankerungstiefe

MATERIALE MATERIAL	BARRA ROD	DIAMETRO BARRA ROD DIAMETER	PROFONDITÀ EFF. ANCORAGGIO EFFECTIVE ANCHORAGE DEPTH	CARICO ULTIMO MEDIO A TRAZIONE	CARICO ULTIMO MEDIO A TAGLIO	CARICO CARATTERISTICO A TRAZIONE	CARICO CARATTERISTICO A TAGLIO	CARICO AMMISSIBILE A TRAZIONE	CARICO AMMISSIBILE A TAGLIO	
				ULTIMATE TENSION LOAD	ULTIMATE SHEAR LOAD	CHARACTERISTIC TENSILE LOAD	CHARACTERISTIC SHEAR LOAD	ADMISSIBLE TENSILE LOAD	ADMISSIBLE SHEAR LOAD	
EPOXY 21 C20/25 Calcestruzzo non fessurato Non cracked Concrete Béton non fissuré Ungerissener Beton		≥ 5.8	M 8	80	19,0	11,4	19,0	9,5	9,0	5,4
		≥ 5.8	M 10	90	30,2	18,1	30,2	15,1	14,3	8,6
		≥ 5.8	M 12	110	43,8	26,2	43,8	21,9	20,8	12,5
		≥ 5.8	M 16	125	81,6	48,9	70,5	40,8	33,6	23,3
		≥ 5.8	M 20	170	127,0	76,2	103,8	63,5	49,4	36,2
		≥ 5.8	M 24	210	184,0	110,4	153,6	92,0	73,1	52,5
		≥ 5.8	M 27	240	239,0	143,4	187,7	119,5	89,4	68,2
		≥ 5.8	M 30	270	292,0	175,2	224,0	146,0	106,6	83,4



**MAX** Dati di carico con profondità effettiva ancoraggio MASSIMO > Load data with MAXIMUM effective anchorage depth  
 Données de charge avec profondeur efficace d'ancrage MAXIMUM > Lastdaten mit MAXIMALER effektiven Verankerungstiefe

MATERIALE MATERIAL	BARRA ROD	DIAMETRO BARRA ROD DIAMETER	PROFONDITÀ EFF. ANCORAGGIO EFFECTIVE ANCHORAGE DEPTH	CARICO ULTIMO MEDIO A TRAZIONE	CARICO ULTIMO MEDIO A TAGLIO	CARICO CARATTERISTICO A TRAZIONE	CARICO CARATTERISTICO A TAGLIO	CARICO AMMISSIBILE A TRAZIONE	CARICO AMMISSIBILE A TAGLIO	
				ULTIMATE TENSION LOAD	ULTIMATE SHEAR LOAD	CHARACTERISTIC TENSILE LOAD	CHARACTERISTIC SHEAR LOAD	ADMISSIBLE TENSILE LOAD	ADMISSIBLE SHEAR LOAD	
EPOXY 21 C20/25 Calcestruzzo non fessurato Non cracked Concrete Béton non fissuré Ungerissener Beton		8.8	M 8	160	29,2	17,5	29,2	14,6	13,9	8,3
		8.8	M 10	200	46,4	27,8	46,4	23,2	22,1	13,2
		8.8	M 12	240	67,4	40,4	67,4	33,7	32,1	19,2
		8.8	M 16	320	125,0	75,0	125,0	62,5	59,5	35,7
		8.8	M 20	400	203,0	121,8	203,0	101,5	96,6	58,0
		8.8	M 24	480	293,0	175,8	293,0	146,5	139,5	83,7
		8.8	M 27	540	381,0	228,6	381,0	190,5	181,4	108,8
		8.8	M 30	600	466,0	279,6	466,0	233,0	221,9	133,1





# SCHEDA TECNICA TECHNICAL DATA SHEET FICHE TECHNIQUE TECHNISCHES DATENBLATT

## Dati carico | Load data | Données de charge | Lastdaten

<b>D N E G L</b>	<b>N<sub>um</sub></b> [kN]	Carico ultimo medio a trazione > Average ultimate tension load > Charge maximum moyenne de traction Durchschnittliche maximale Zuglast
	<b>V<sub>um</sub></b> [kN]	Carico ultimo medio a taglio > Average ultimate shear load > Charge maximum moyenne de cisaillement Durchschnittliche maximale Querlast
	<b>N<sub>rk</sub></b> [kN]	Carico caratteristico a trazione > Characteristic tension load > Charge caractéristique de traction Charakteristische Zuglast
	<b>V<sub>rk</sub></b> [kN]	Carico caratteristico a taglio > Characteristic shear load > Charge caractéristique de cisaillement Charakteristische Querlast
	<b>N<sub>rec</sub></b> [kN]	Carico ammissibile a trazione > Admissible tensile load > Charge admissible de traction > Zulässige Zuglast
	<b>V<sub>rec</sub></b> [kN]	Carico ammissibile a taglio > Admissible shear load > Charge admissible de cisaillement > Zulässige Querlast



> Carichi validi per singolo ancorante senza influenza di interasse e distanza dal bordo e  $h \geq 2h_{ef}$  > 1kN = 100 Kg  
> Loads for single anchor with no influence of spacing and edge distance and with  $h \geq 2h_{ef}$   
> Charges valables pour chaque ancrage sans influence d'interaxe et distance du bord et  $h \geq 2h_{ef}$   
> Passende Ringe für den einzelnen Veranker, ohne Achsenabstandseinfluss und des Randabstands und  $h \geq 2h_{ef}$

> Azione di taglio non diretta verso il bordo > Coefficiente di sicurezza globale incluso > Coefficiente lato carichi utilizzato = 1,4  
> Shear directed away from the edge > General safety factor included > Load increasing safety coefficient used = 1,4  
> Action de cisaillement pas dirigée vers le bord > Coefficient de sécurité générale inclu > Coefficient côté charge utilisé = 1,4  
> Queraktion nicht an den Rand gerichtet > Generelle Sicherheitskoeffizient inbegriffen > Verwendeter Lasterhöhungssicherheitskoeffizient = 1,4

Con foro allagato, riduzione del carico consigliato del 20%  
With flooded hole, reduction of the recommended load of 20%



## MIN Dati di carico con profondità effettiva ancoraggio MINIMA > Load data with MINIMUM effective anchorage depth Donnes de charge avec profondeur efficace d'ancrage MINIMALE > Lastdaten mit MINIMUM effektive Verankerungstiefe

EPOXY 21 MATERIALE MATERIAL	BARRA ROD	DIAMETRO BARRA ROD DIAMETER	PROFONDITÀ EFF. ANCORAGGIO EFFECTIVE ANCHORAGE DEPTH	CARICO ULTIMO MEDIO A TRAZIONE ULTIMATE TENSION LOAD	CARICO ULTIMO MEDIO A TAGLIO ULTIMATE SHEAR LOAD	CARICO CARATTERISTICO A TRAZIONE CHARACTERISTIC TENSILE LOAD	CARICO CARATTERISTICO A TAGLIO CHARACTERISTIC SHEAR LOAD	CARICO AMMISSIBILE A TRAZIONE ADMISSIBLE TENSILE LOAD	CARICO AMMISSIBILE A TAGLIO ADMISSIBLE SHEAR LOAD	
			d [mm]	$h_{ef MIN}$ [mm]	$N_{um}$ [kN]	$V_{um}$ [kN]	$N_{rk}$ [kN]	$V_{rk}$ [kN]	$N_{rec}$ [kN]	$V_{rec}$ [kN]
C20/25 Calcestruzzo fessurato Cracked Concrete Beton fissuré Gerissener Beton	 $\geq 5.8$	$\geq 5.8$	M 12	70	27,8	26,2	15,8	21,9	7,5	12,5
		$\geq 5.8$	M 16	80	33,9	48,9	20,8	40,8	9,9	19,8
		$\geq 5.8$	M 20	90	40,5	76,2	30,7	61,5	14,6	29,2
		$\geq 5.8$	M 24	96	44,6	89,3	33,8	67,7	16,2	32,2



## MED Dati di carico con profondità effettiva ancoraggio MEDIA > Load data with MEDIUM effective anchorage depth Donnes de charge avec profondeur efficace d'ancrage MOYENNE > Lastdaten mit MITTEL effektive Verankerungstiefe

EPOXY 21 MATERIALE MATERIAL	BARRA ROD	DIAMETRO BARRA ROD DIAMETER	PROFONDITÀ EFF. ANCORAGGIO EFFECTIVE ANCHORAGE DEPTH	CARICO ULTIMO MEDIO A TRAZIONE ULTIMATE TENSION LOAD	CARICO ULTIMO MEDIO A TAGLIO ULTIMATE SHEAR LOAD	CARICO CARATTERISTICO A TRAZIONE CHARACTERISTIC TENSILE LOAD	CARICO CARATTERISTICO A TAGLIO CHARACTERISTIC SHEAR LOAD	CARICO AMMISSIBILE A TRAZIONE ADMISSIBLE TENSILE LOAD	CARICO AMMISSIBILE A TAGLIO ADMISSIBLE SHEAR LOAD	
			d [mm]	$h_{ef MED}$ [mm]	$N_{um}$ [kN]	$V_{um}$ [kN]	$N_{rk}$ [kN]	$V_{rk}$ [kN]	$N_{rec}$ [kN]	$V_{rec}$ [kN]
C20/25 Calcestruzzo fessurato Cracked Concrete Beton fissuré Gerissener Beton	 $\geq 5.8$	$\geq 5.8$	M 12	110	43,8	26,2	24,8	21,9	11,8	12,5
		$\geq 5.8$	M 16	125	66,3	48,9	32,6	40,8	15,5	23,3
		$\geq 5.8$	M 20	170	105,2	76,2	60,7	63,5	28,9	36,2
		$\geq 5.8$	M 24	210	144,5	110,4	92,0	92,0	43,8	52,5



## MAX Dati di carico con profondità effettiva ancoraggio MASSIMO > Load data with MAXIMUM effective anchorage depth Donnes de charge avec profondeur efficace d'ancrage MAXIMUM > Lastdaten mit MAXIMUM effektive Verankerungstiefe

EPOXY 21 MATERIALE MATERIAL	BARRA ROD	DIAMETRO BARRA ROD DIAMETER	PROFONDITÀ EFF. ANCORAGGIO EFFECTIVE ANCHORAGE DEPTH	CARICO ULTIMO MEDIO A TRAZIONE ULTIMATE TENSION LOAD	CARICO ULTIMO MEDIO A TAGLIO ULTIMATE SHEAR LOAD	CARICO CARATTERISTICO A TRAZIONE CHARACTERISTIC TENSILE LOAD	CARICO CARATTERISTICO A TAGLIO CHARACTERISTIC SHEAR LOAD	CARICO AMMISSIBILE A TRAZIONE ADMISSIBLE TENSILE LOAD	CARICO AMMISSIBILE A TAGLIO ADMISSIBLE SHEAR LOAD	
			d [mm]	$h_{ef MAX}$ [mm]	$N_{um}$ [kN]	$V_{um}$ [kN]	$N_{rk}$ [kN]	$V_{rk}$ [kN]	$N_{rec}$ [kN]	$V_{rec}$ [kN]
C20/25 Calcestruzzo fessurato Cracked Concrete Beton fissuré Gerissener Beton	 $8.8$	8.8	M 12	240	67,4	40,4	54,2	33,7	25,8	19,2
		8.8	M 16	320	125,0	75,0	83,5	62,5	39,7	35,7
		8.8	M 20	400	203,0	121,8	143,0	101,5	68,1	58,0
		8.8	M 24	480	293,0	175,8	210,3	146,5	100,1	83,7





**Dati carico | Load data | Données de charge | Lastdaten**

<b>LEGGENDA</b>	<b>N<sub>rum</sub></b> [kN]	Carico ultimo medio a trazione > Average ultimate tension load > Charge maximum moyenne de traction Durchschnittliche maximale Zuglast
	<b>V<sub>rum</sub></b> [kN]	Carico ultimo medio a taglio > Average ultimate shear load > Charge maximum moyenne de cisaillement Durchschnittliche maximale Querlast
	<b>N<sub>rk</sub></b> [kN]	Carico caratteristico a trazione > Characteristic tension load > Charge caractéristique de traction Charakteristische Zuglast
	<b>V<sub>rk</sub></b> [kN]	Carico caratteristico a taglio > Characteristic shear load > Charge caractéristique de cisaillement Charakteristische Querlast
	<b>N<sub>rec</sub></b> [kN]	Carico ammissibile a trazione > Admissible tensile load > Charge admissible de traction > Zulässige Zuglast
	<b>V<sub>rec</sub></b> [kN]	Carico ammissibile a taglio > Admissible shear load > Charge admissible de cisaillement > Zulässige Querlast

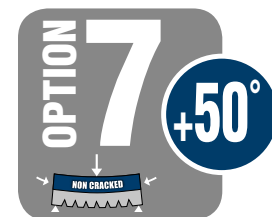

> Carichi validi per singolo ancorante senza influenza di interasse e distanza dal bordo e  $h \geq 2h_f$  > 1kN = 100 Kg  
> Loads for single anchor with no influence of spacing and edge distance and with  $h \geq 2h_f$   
> Charges valables pour chaque ancrage sans influence d'interaxe et distance du bord et  $h \geq 2h_f$   
> Passende Ringe für den einzelnen Veranker, ohne Achsenabstandseinfluss und des Randabstands und  $h \geq 2h_f$

> Azione di taglio non diretta verso il bordo > Coefficiente di sicurezza globale incluso > Coefficiente lato carichi utilizzato = 1,4  
> Shear directed away from the edge > General safety factor included > Load increasing safety coefficient used = 1,4  
> Action de cisaillement pas dirigée vers le bord > Coefficient de sécurité générale inclu > Coefficient côté charge utilisé = 1,4  
> Queraktion nicht an den Rand gerichtet > Generelle Sicherheitskoeffizient inbegriffen > Verwendeter Lasterhöhungssicherheitskoeffizient = 1,4

Con foro allagato, riduzione del carico consigliato del 20%  
With flooded hole, reduction of the recommended load of 20%

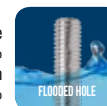

**MIN** Dati di carico con profondità effettiva ancoraggio MINIMA > Load data with MINIMUM effective anchorage depth  
Donnes de charge avec profondeur efficace d'ancrage MINIMALE > Lastdaten mit MINIMUM effektive Verankerungstiefe

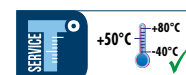

EPOXY 21 MATERIALE MATERIAL	BARRA ROD	DIAMETRO BARRA ROD DIAMETER	PROFONDITÀ EFF. ANCORAGGIO EFFECTIVE ANCHORAGE DEPTH	CARICO ULTIMO MEDIO A TRAZIONE ULTIMATE TENSION LOAD	CARICO ULTIMO MEDIO A TAGLIO ULTIMATE SHEAR LOAD	CARICO CARATTERISTICO A TRAZIONE CHARACTERISTIC TENSILE LOAD	CARICO CARATTERISTICO A TAGLIO CHARACTERISTIC SHEAR LOAD	CARICO AMMISSIBILE A TRAZIONE ADMISSIBLE TENSILE LOAD	CARICO AMMISSIBILE A TAGLIO ADMISSIBLE SHEAR LOAD		
				N <sub>rum</sub> [kN]	V <sub>rum</sub> [kN]	N <sub>rk</sub> [kN]	V <sub>rk</sub> [kN]	N <sub>rec</sub> [kN]	V <sub>rec</sub> [kN]		
C20/25 Calcestruzzo non fessurato Non cracked Concrete Beton non fissuré Ungerissener Beton		$\geq 5.8$	d [mm]	h <sub>ef MIN</sub> [mm]							
			$\geq 5.8$	M 8	60	19,0	11,4	13,5	9,5	6,4	5,4
			$\geq 5.8$	M 10	60	25,4	18,1	15,8	15,1	7,5	8,6
			$\geq 5.8$	M 12	70	39,4	26,2	22,2	21,9	10,5	12,5
			$\geq 5.8$	M 16	80	48,3	48,9	35,4	40,8	16,8	23,3
			$\geq 5.8$	M 20	90	57,6	76,2	41,5	63,5	19,7	36,2
			$\geq 5.8$	M 24	96	63,4	110,4	47,5	92,0	22,6	45,2
			$\geq 5.8$	M 27	110	77,8	143,4	58,2	116,5	27,7	55,4
$\geq 5.8$	M 30	120	88,7	175,2	66,3	132,8	31,6	63,2			

**MED** Dati di carico con profondità effettiva ancoraggio MEDIA > Load data with MEDIUM effective anchorage depth  
Donnes de charge avec profondeur efficace d'ancrage MOYENNE > Lastdaten mit MITTEL effektive Verankerungstiefe



EPOXY 21 MATERIALE MATERIAL	BARRA ROD	DIAMETRO BARRA ROD DIAMETER	PROFONDITÀ EFF. ANCORAGGIO EFFECTIVE ANCHORAGE DEPTH	CARICO ULTIMO MEDIO A TRAZIONE ULTIMATE TENSION LOAD	CARICO ULTIMO MEDIO A TAGLIO ULTIMATE SHEAR LOAD	CARICO CARATTERISTICO A TRAZIONE CHARACTERISTIC TENSILE LOAD	CARICO CARATTERISTICO A TAGLIO CHARACTERISTIC SHEAR LOAD	CARICO AMMISSIBILE A TRAZIONE ADMISSIBLE TENSILE LOAD	CARICO AMMISSIBILE A TAGLIO ADMISSIBLE SHEAR LOAD		
				N <sub>rum</sub> [kN]	V <sub>rum</sub> [kN]	N <sub>rk</sub> [kN]	V <sub>rk</sub> [kN]	N <sub>rec</sub> [kN]	V <sub>rec</sub> [kN]		
C20/25 Calcestruzzo non fessurato Non cracked Concrete Beton non fissuré Ungerissener Beton		$\geq 5.8$	d [mm]	h <sub>ef MED</sub> [mm]							
			$\geq 5.8$	M 8	80	19,0	11,4	18,0	9,5	8,6	5,4
			$\geq 5.8$	M 10	90	30,2	18,1	23,8	15,1	11,3	8,6
			$\geq 5.8$	M 12	110	43,8	26,2	34,9	21,9	16,6	12,5
			$\geq 5.8$	M 16	125	81,6	48,9	55,3	40,8	26,3	23,3
			$\geq 5.8$	M 20	170	127,0	76,2	78,4	63,5	37,3	36,2
			$\geq 5.8$	M 24	210	184,0	110,4	142,8	92,0	68,0	52,5
			$\geq 5.8$	M 27	240	239,0	143,4	182,2	119,5	86,8	68,2
$\geq 5.8$	M 30	270	292,0	175,2	211,5	146,0	100,7	83,4			

**MAX** Dati di carico con profondità effettiva ancoraggio MASSIMO > Load data with MAXIMUM effective anchorage depth  
Donnes de charge avec profondeur efficace d'ancrage MAXIMUM > Lastdaten mit MAXIMUM effektive Verankerungstiefe



EPOXY 21 MATERIALE MATERIAL	BARRA ROD	DIAMETRO BARRA ROD DIAMETER	PROFONDITÀ EFF. ANCORAGGIO EFFECTIVE ANCHORAGE DEPTH	CARICO ULTIMO MEDIO A TRAZIONE ULTIMATE TENSION LOAD	CARICO ULTIMO MEDIO A TAGLIO ULTIMATE SHEAR LOAD	CARICO CARATTERISTICO A TRAZIONE CHARACTERISTIC TENSILE LOAD	CARICO CARATTERISTICO A TAGLIO CHARACTERISTIC SHEAR LOAD	CARICO AMMISSIBILE A TRAZIONE ADMISSIBLE TENSILE LOAD	CARICO AMMISSIBILE A TAGLIO ADMISSIBLE SHEAR LOAD		
				N <sub>rum</sub> [kN]	V <sub>rum</sub> [kN]	N <sub>rk</sub> [kN]	V <sub>rk</sub> [kN]	N <sub>rec</sub> [kN]	V <sub>rec</sub> [kN]		
C20/25 Calcestruzzo non fessurato Non cracked Concrete Beton non fissuré Ungerissener Beton		8.8	d [mm]	h <sub>ef MAX</sub> [mm]							
			8.8	M 8	160	29,2	17,5	29,2	14,6	13,9	8,3
			8.8	M 10	200	46,4	27,8	46,4	23,2	22,1	13,2
			8.8	M 12	240	67,4	40,4	67,4	33,7	32,1	19,2
			8.8	M 16	320	125,0	75,0	125,0	62,5	59,5	35,7
			8.8	M 20	400	203,0	121,8	184,6	101,5	87,9	58,0
			8.8	M 24	480	293,0	175,8	293,0	146,5	139,5	83,7
			8.8	M 27	540	381,0	228,6	381,0	190,5	181,4	108,8
8.8	M 30	600	466,0	279,6	466,0	233,0	221,9	133,1			



# SCHEDA TECNICA TECHNICAL DATA SHEET FICHE TECHNIQUE TECHNISCHES DATENBLATT

## Dati carico | Load data | Données de charge | Lastdaten

<b>D</b>	$N_{rum}$ [kN]	Carico ultimo medio a trazione > Average ultimate tension load > Charge maximum moyenne de traction Durchschnittliche maximale Zuglast
	$V_{rum}$ [kN]	Carico ultimo medio a taglio > Average ultimate shear load > Charge maximum moyenne de cisaillement Durchschnittliche maximale Querlast
<b>E</b>	$N_{rk}$ [kN]	Carico caratteristico a trazione > Characteristic tension load > Charge caractéristique de traction Charakteristische Zuglast
	$V_{rk}$ [kN]	Carico caratteristico a taglio > Characteristic shear load > Charge caractéristique de cisaillement Charakteristische Querlast
<b>L</b>	$N_{rec}$ [kN]	Carico ammissibile a trazione > Admissible tensile load > Charge admissible de traction > Zulässige Zuglast
	$V_{rec}$ [kN]	Carico ammissibile a taglio > Admissible shear load > Charge admissible de cisaillement > Zulässige Querlast

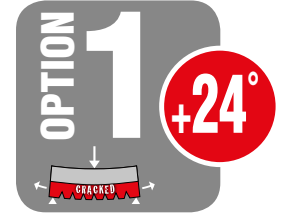

> Carichi validi per singolo ancorante senza influenza di interasse e distanza dal bordo e  $h \geq 2h_f$  > 1kN = 100 Kg  
> Loads for single anchor with no influence of spacing and edge distance and with  $h \geq 2h_f$   
> Charges valables pour chaque ancrage sans influence d'interaxe et distance du bord et  $h \geq 2h_f$   
> Passende Ringe für den einzelnen Veranker, ohne Achsenabstandseinfluss und des Randabstands und  $h \geq 2h_f$

> Azione di taglio non diretta verso il bordo > Coefficiente di sicurezza globale incluso > Coefficiente lato carichi utilizzato = 1,4  
> Shear directed away from the edge > General safety factor included > Load increasing safety coefficient used = 1,4  
> Action de cisaillement pas dirigée vers le bord > Coefficient de sécurité générale inclu > Coefficient côté charge utilisé = 1,4  
> Queraktion nicht an den Rand gerichtet > Generelle Sicherheitskoeffizient inbegriffen > Verwendeter Lasterhöhungssicherheitskoeffizient = 1,4

Con foro allagato, riduzione del carico consigliato del 20%  
With flooded hole, reduction of the recommended load of 20%



**MIN** Dati di carico con profondità effettiva ancoraggio MINIMA > Load data with MINIMUM effective anchorage depth  
Donnes de charge avec profondeur efficace d'ancrage MINIMALE > Lastdaten mit MINIMALER effektiven Verankerungstiefe

EPOXY 21 MATERIALE MATERIAL	BARRA ROD	DIAMETRO BARRA ROD DIAMETER	PROFONDITÀ EFF. ANCORAGGIO EFFECTIVE ANCHORAGE DEPTH	CARICO ULTIMO MEDIO A TRAZIONE ULTIMATE TENSION LOAD	CARICO ULTIMO MEDIO A TAGLIO ULTIMATE SHEAR LOAD	CARICO CARATTERISTICO A TRAZIONE CHARACTERISTIC TENSILE LOAD	CARICO CARATTERISTICO A TAGLIO CHARACTERISTIC SHEAR LOAD	CARICO AMMISSIBILE A TRAZIONE ADMISSIBLE TENSILE LOAD	CARICO AMMISSIBILE A TAGLIO ADMISSIBLE SHEAR LOAD
C20/25 Calcestruzzo fessurato Cracked Concrete Beton fissuré Gerissener Beton  C20/25 A4-70	A4-70	M12	70	27,8	35,4	20,9	29,5	9,9	13,5
	A4-70	M16	80	33,9	65,9	25,7	41,7	12,2	19,8
	A4-70	M20	90	40,5	81,1	30,7	61,4	14,6	29,2
	A4-70	M24	96	44,6	89,3	33,8	67,7	16,1	32,2

**MED** Dati di carico con profondità effettiva ancoraggio MEDIA > Load data with MEDIUM effective anchorage depth  
Donnes de charge avec profondeur efficace d'ancrage MOYENNE > Lastdaten mit MITTLERER effektiven Verankerungstiefe

EPOXY 21 MATERIALE MATERIAL	BARRA ROD	DIAMETRO BARRA ROD DIAMETER	PROFONDITÀ EFF. ANCORAGGIO EFFECTIVE ANCHORAGE DEPTH	CARICO ULTIMO MEDIO A TRAZIONE ULTIMATE TENSION LOAD	CARICO ULTIMO MEDIO A TAGLIO ULTIMATE SHEAR LOAD	CARICO CARATTERISTICO A TRAZIONE CHARACTERISTIC TENSILE LOAD	CARICO CARATTERISTICO A TAGLIO CHARACTERISTIC SHEAR LOAD	CARICO AMMISSIBILE A TRAZIONE ADMISSIBLE TENSILE LOAD	CARICO AMMISSIBILE A TAGLIO ADMISSIBLE SHEAR LOAD
C20/25 Calcestruzzo fessurato Cracked Concrete Beton fissuré Gerissener Beton  C20/25 A4-70	A4-70	M12	110	54,8	35,4	32,9	29,5	15,6	13,5
	A4-70	M16	125	66,3	65,9	43,1	54,9	20,5	25,1
	A4-70	M20	170	105,2	102,9	79,7	85,7	37,9	39,2
	A4-70	M24	210	144,5	148,2	109,5	123,5	52,1	56,5

**MAX** Dati di carico con profondità effettiva ancoraggio MASSIMO > Load data with MAXIMUM effective anchorage depth  
Donnes de charge avec profondeur efficace d'ancrage MAXIMUM > Lastdaten mit MAXIMALER effektiven Verankerungstiefe

EPOXY 21 MATERIALE MATERIAL	BARRA ROD	DIAMETRO BARRA ROD DIAMETER	PROFONDITÀ EFF. ANCORAGGIO EFFECTIVE ANCHORAGE DEPTH	CARICO ULTIMO MEDIO A TRAZIONE ULTIMATE TENSION LOAD	CARICO ULTIMO MEDIO A TAGLIO ULTIMATE SHEAR LOAD	CARICO CARATTERISTICO A TRAZIONE CHARACTERISTIC TENSILE LOAD	CARICO CARATTERISTICO A TAGLIO CHARACTERISTIC SHEAR LOAD	CARICO AMMISSIBILE A TRAZIONE ADMISSIBLE TENSILE LOAD	CARICO AMMISSIBILE A TAGLIO ADMISSIBLE SHEAR LOAD
C20/25 Calcestruzzo fessurato Cracked Concrete Beton fissuré Gerissener Beton  C20/25 A4-70	A4-70	M12	240	59,0	35,4	59,0	29,5	22,5	13,5
	A4-70	M16	320	109,9	65,9	109,9	54,9	41,9	25,1
	A4-70	M20	400	171,5	102,9	171,5	85,7	65,5	39,2
	A4-70	M24	480	247,1	148,2	247,1	123,5	94,3	56,5



**Dati carico | Load data | Données de charge | Lastdaten**

<b>D N E G L</b>	<b>N<sub>rum</sub></b> [kN]	Carico ultimo medio a trazione > Average ultimate tension load > Charge maximum moyenne de traction Durchschnittliche maximale Zuglast
	<b>V<sub>rum</sub></b> [kN]	Carico ultimo medio a taglio > Average ultimate shear load > Charge maximum moyenne de cisaillement Durchschnittliche maximale Querlast
	<b>N<sub>rk</sub></b> [kN]	Carico caratteristico a trazione > Characteristic tension load > Charge caractéristique de traction Charakteristische Zuglast
	<b>V<sub>rk</sub></b> [kN]	Carico caratteristico a taglio > Characteristic shear load > Charge caractéristique de cisaillement Charakteristische Querlast
	<b>N<sub>rec</sub></b> [kN]	Carico ammissibile a trazione > Admissible tensile load > Charge admissible de traction > Zulässige Zuglast
	<b>V<sub>rec</sub></b> [kN]	Carico ammissibile a taglio > Admissible shear load > Charge admissible de cisaillement > Zulässige Querlast

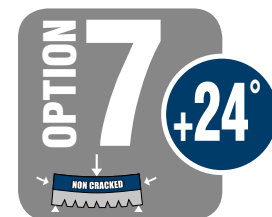

> Carichi validi per singolo ancorante senza influenza di interasse e distanza dal bordo e  $h \geq 2h_{ef}$  > 1kN = 100 Kg  
 > Loads for single anchor with no influence of spacing and edge distance and with  $h \geq 2h_{ef}$   
 > Charges valables pour chaque ancrage sans influence d'interaxe et distance du bord et  $h \geq 2h_{ef}$   
 > Passende Ringe für den einzelnen Veranker, ohne Achsenabstandseinfluss und des Randabstands und  $h \geq 2h_{ef}$

> Azione di taglio non diretta verso il bordo > Coefficiente di sicurezza globale incluso > Coefficiente lato carichi utilizzato = 1,4  
 > Shear directed away from the edge > General safety factor included > Load increasing safety coefficient used = 1,4  
 > Action de cisaillement pas dirigée vers le bord > Coefficient de sécurité générale inclu > Coefficient côté charge utilisé = 1,4  
 > Queraktion nicht an den Rand gerichtet > Generelle Sicherheitskoeffizient inbegriffen > Verwendeter Lasterhöhungssicherheitskoeffizient = 1,4

Con foro allagato, riduzione del carico consigliato del 20%  
With flooded hole, reduction of the recommended load of 20%

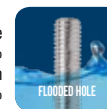

**MIN** Dati di carico con profondità effettiva ancoraggio MINIMA > Load data with MINIMUM effective anchorage depth  
Donnes de charge avec profondeur efficace d'ancrage MINIMALE > Lastdaten mit MINIMALER effektiven Verankerungstiefe

MATERIALE MATERIAL	BARRA ROD	DIAMETRO BARRA ROD DIAMETER	PROFONDITÀ EFF. ANCORAGGIO EFFECTIVE ANCHORAGE DEPTH	CARICO ULTIMO MEDIO A TRAZIONE	CARICO ULTIMO MEDIO A TAGLIO	CARICO CARATTERISTICO A TRAZIONE	CARICO CARATTERISTICO A TAGLIO	CARICO AMMISSIBILE A TRAZIONE	CARICO AMMISSIBILE A TAGLIO
				ULTIMATE TENSION LOAD	ULTIMATE SHEAR LOAD	CHARACTERISTIC TENSILE LOAD	CHARACTERISTIC SHEAR LOAD	ADMISSIBLE TENSILE LOAD	ADMISSIBLE SHEAR LOAD
EPOXY 21		d [mm]	h <sub>ef MIN</sub> [mm]	N <sub>rum</sub> [kN]	V <sub>rum</sub> [kN]	N <sub>rk</sub> [kN]	V <sub>rk</sub> [kN]	N <sub>rec</sub> [kN]	V <sub>rec</sub> [kN]
C20/25 Calcestruzzo non fessurato Non cracked Concrete Béton non fissuré Ungerissener Beton	A4-70	M8	60	21,2	15,3	17,9	12,8	8,5	5,8
	A4-70	M10	60	25,4	24,3	20,9	20,3	9,9	9,2
	A4-70	M12	70	39,4	35,4	29,3	29,5	13,9	13,5
	A4-70	M16	80	48,2	65,9	36,1	54,9	17,2	25,1
	A4-70	M20	90	57,6	102,9	43,1	83,0	20,5	39,2
	A4-70	M24	96	63,4	126,9	47,5	95,0	22,6	45,2
	A4-70	M27	110	77,8	155,7	58,2	116,5	27,7	55,4
	A4-70	M30	120	88,7	177,4	66,3	132,7	31,6	63,2

**MED** Dati di carico con profondità effettiva ancoraggio MEDIA > Load data with MEDIUM effective anchorage depth  
Donnes de charge avec profondeur efficace d'ancrage MOYENNE > Lastdaten mit MITTLERER effektiven Verankerungstiefe

MATERIALE MATERIAL	BARRA ROD	DIAMETRO BARRA ROD DIAMETER	PROFONDITÀ EFF. ANCORAGGIO EFFECTIVE ANCHORAGE DEPTH	CARICO ULTIMO MEDIO A TRAZIONE	CARICO ULTIMO MEDIO A TAGLIO	CARICO CARATTERISTICO A TRAZIONE	CARICO CARATTERISTICO A TAGLIO	CARICO AMMISSIBILE A TRAZIONE	CARICO AMMISSIBILE A TAGLIO
				ULTIMATE TENSION LOAD	ULTIMATE SHEAR LOAD	CHARACTERISTIC TENSILE LOAD	CHARACTERISTIC SHEAR LOAD	ADMISSIBLE TENSILE LOAD	ADMISSIBLE SHEAR LOAD
EPOXY 21		d [mm]	h <sub>ef MED</sub> [mm]	N <sub>rum</sub> [kN]	V <sub>rum</sub> [kN]	N <sub>rk</sub> [kN]	V <sub>rk</sub> [kN]	N <sub>rec</sub> [kN]	V <sub>rec</sub> [kN]
C20/25 Calcestruzzo non fessurato Non cracked Concrete Béton non fissuré Ungerissener Beton	A4-70	M8	80	25,6	15,3	23,9	12,8	9,7	5,8
	A4-70	M10	90	38,1	24,3	31,4	20,3	14,9	9,2
	A4-70	M12	110	59,0	35,4	46,1	29,5	21,9	13,5
	A4-70	M16	125	90,9	65,9	70,5	54,9	33,6	25,1
	A4-70	M20	170	146,8	102,9	103,8	85,7	49,4	39,2
	A4-70	M24	210	205,4	148,2	153,6	123,5	73,1	56,5
	A4-70	M27	240	250,9	192,7	187,7	160,6	89,4	73,5
	A4-70	M30	270	299,4	235,6	224,0	196,3	106,6	89,9

**MAX** Dati di carico con profondità effettiva ancoraggio MASSIMO > Load data with MAXIMUM effective anchorage depth  
Donnes de charge avec profondeur efficace d'ancrage MAXIMUM > Lastdaten mit MAXIMALER effektiven Verankerungstiefe

MATERIALE MATERIAL	BARRA ROD	DIAMETRO BARRA ROD DIAMETER	PROFONDITÀ EFF. ANCORAGGIO EFFECTIVE ANCHORAGE DEPTH	CARICO ULTIMO MEDIO A TRAZIONE	CARICO ULTIMO MEDIO A TAGLIO	CARICO CARATTERISTICO A TRAZIONE	CARICO CARATTERISTICO A TAGLIO	CARICO AMMISSIBILE A TRAZIONE	CARICO AMMISSIBILE A TAGLIO
				ULTIMATE TENSION LOAD	ULTIMATE SHEAR LOAD	CHARACTERISTIC TENSILE LOAD	CHARACTERISTIC SHEAR LOAD	ADMISSIBLE TENSILE LOAD	ADMISSIBLE SHEAR LOAD
EPOXY 21		d [mm]	h <sub>ef MAX</sub> [mm]	N <sub>rum</sub> [kN]	V <sub>rum</sub> [kN]	N <sub>rk</sub> [kN]	V <sub>rk</sub> [kN]	N <sub>rec</sub> [kN]	V <sub>rec</sub> [kN]
C20/25 Calcestruzzo non fessurato Non cracked Concrete Béton non fissuré Ungerissener Beton	A4-70	M8	160	25,6	15,3	25,6	12,8	9,7	5,8
	A4-70	M10	200	40,6	24,3	40,6	20,3	15,5	9,2
	A4-70	M12	240	59,0	35,4	59,0	29,5	22,5	13,5
	A4-70	M16	320	109,9	65,9	109,9	54,9	41,9	25,1
	A4-70	M20	400	171,5	102,9	171,5	85,7	65,5	39,2
	A4-70	M24	480	247,1	148,2	247,1	123,5	94,3	56,5
	A4-70	M27	540	321,3	192,7	321,3	160,6	122,7	73,5
	A4-70	M30	600	392,7	235,6	392,7	196,3	150,0	89,9



# SCHEDA TECNICA TECHNICAL DATA SHEET FICHE TECHNIQUE TECHNISCHES DATENBLATT

## Dati carico | Load data | Données de charge | Lastdaten

<b>D</b>	$N_{rum}$ [kN]	Carico ultimo medio a trazione > Average ultimate tension load > Charge maximum moyenne de traction Durchschnittliche maximale Zuglast
	$V_{rum}$ [kN]	Carico ultimo medio a taglio > Average ultimate shear load > Charge maximum moyenne de cisaillement Durchschnittliche maximale Querlast
<b>E</b>	$N_{rk}$ [kN]	Carico caratteristico a trazione > Characteristic tension load > Charge caractéristique de traction Charakteristische Zuglast
	$V_{rk}$ [kN]	Carico caratteristico a taglio > Characteristic shear load > Charge caractéristique de cisaillement Charakteristische Querlast
<b>L</b>	$N_{rec}$ [kN]	Carico ammissibile a trazione > Admissible tensile load > Charge admissible de traction > Zulässige Zuglast
	$V_{rec}$ [kN]	Carico ammissibile a taglio > Admissible shear load > Charge admissible de cisaillement > Zulässige Querlast

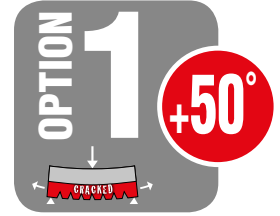

> Carichi validi per singolo ancorante senza influenza di interasse e distanza dal bordo e  $h \geq 2h_{ef}$  > 1kN = 100 Kg  
> Loads for single anchor with no influence of spacing and edge distance and with  $h \geq 2h_{ef}$   
> Charges valables pour chaque ancrage sans influence d'interaxe et distance du bord et  $h \geq 2h_{ef}$   
> Passende Ringe für den einzelnen Veranker, ohne Achsenabstandseinfluss und des Randabstands und  $h \geq 2h_{ef}$

> Azione di taglio non diretta verso il bordo > Coefficiente di sicurezza globale incluso > Coefficiente lato carichi utilizzato = 1,4  
> Shear directed away from the edge > General safety factor included > Load increasing safety coefficient used = 1,4  
> Action de cisaillement pas dirigée vers le bord > Coefficient de sécurité générale inclu > Coefficient côté charge utilisé = 1,4  
> Queraktion nicht an den Rand gerichtet > Generelle Sicherheitskoeffizient inbegriffen > Verwendeter Lasterhöhungssicherheitskoeffizient = 1,4

Con foro allagato, riduzione del carico consigliato del 20%  
With flooded hole, reduction of the recommended load of 20%



## MIN Dati di carico con profondità effettiva ancoraggio MINIMA > Load data with MINIMUM effective anchorage depth Donnes de charge avec profondeur efficace d'ancrage MINIMALE > Lastdaten mit MINIMUM effektive Verankerungstiefe

EPOXY 21 MATERIALE MATERIAL	BARRA ROD	DIAMETRO BARRA ROD DIAMETER	PROFONDITÀ EFF. ANCORAGGIO EFFECTIVE ANCHORAGE DEPTH	CARICO ULTIMO MEDIO A TRAZIONE ULTIMATE TENSION LOAD	CARICO ULTIMO MEDIO A TAGLIO ULTIMATE SHEAR LOAD	CARICO CARATTERISTICO A TRAZIONE CHARACTERISTIC TENSILE LOAD	CARICO CARATTERISTICO A TAGLIO CHARACTERISTIC SHEAR LOAD	CARICO AMMISSIBILE A TRAZIONE ADMISSIBLE TENSILE LOAD	CARICO AMMISSIBILE A TAGLIO ADMISSIBLE SHEAR LOAD
			$h_{ef MIN}$ [mm]	$N_{rum}$ [kN]	$V_{rum}$ [kN]	$N_{rk}$ [kN]	$V_{rk}$ [kN]	$N_{rec}$ [kN]	$V_{rec}$ [kN]
C20/25 Calcestruzzo fessurato Cracked Concrete Beton fissuré Gerissener Beton	A4-70	M12	70	27,8	35,4	15,8	29,5	7,5	13,5
	A4-70	M16	80	33,9	65,9	20,8	41,7	9,9	19,8
	A4-70	M20	90	40,5	81,1	30,7	61,4	14,6	29,2
	A4-70	M24	96	44,6	89,3	33,8	67,7	16,1	32,2

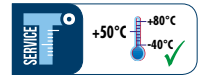

## MED Dati di carico con profondità effettiva ancoraggio MEDIA > Load data with MEDIUM effective anchorage depth Donnes de charge avec profondeur efficace d'ancrage MOYENNE > Lastdaten mit MITTEL effektive Verankerungstiefe

EPOXY 21 MATERIALE MATERIAL	BARRA ROD	DIAMETRO BARRA ROD DIAMETER	PROFONDITÀ EFF. ANCORAGGIO EFFECTIVE ANCHORAGE DEPTH	CARICO ULTIMO MEDIO A TRAZIONE ULTIMATE TENSION LOAD	CARICO ULTIMO MEDIO A TAGLIO ULTIMATE SHEAR LOAD	CARICO CARATTERISTICO A TRAZIONE CHARACTERISTIC TENSILE LOAD	CARICO CARATTERISTICO A TAGLIO CHARACTERISTIC SHEAR LOAD	CARICO AMMISSIBILE A TRAZIONE ADMISSIBLE TENSILE LOAD	CARICO AMMISSIBILE A TAGLIO ADMISSIBLE SHEAR LOAD
			$h_{ef MED}$ [mm]	$N_{rum}$ [kN]	$V_{rum}$ [kN]	$N_{rk}$ [kN]	$V_{rk}$ [kN]	$N_{rec}$ [kN]	$V_{rec}$ [kN]
C20/25 Calcestruzzo fessurato Cracked Concrete Beton fissuré Gerissener Beton	A4-70	M12	110	54,8	35,4	24,8	29,5	11,8	13,5
	A4-70	M16	125	66,3	65,9	32,6	54,9	15,5	25,1
	A4-70	M20	170	105,2	102,9	60,7	85,7	28,9	39,2
	A4-70	M24	210	144,5	148,2	92,0	123,5	43,8	56,5



## MAX Dati di carico con profondità effettiva ancoraggio MASSIMO > Load data with MAXIMUM effective anchorage depth Donnes de charge avec profondeur efficace d'ancrage MAXIMUM > Lastdaten mit MAXIMUM effektive Verankerungstiefe

EPOXY 21 MATERIALE MATERIAL	BARRA ROD	DIAMETRO BARRA ROD DIAMETER	PROFONDITÀ EFF. ANCORAGGIO EFFECTIVE ANCHORAGE DEPTH	CARICO ULTIMO MEDIO A TRAZIONE ULTIMATE TENSION LOAD	CARICO ULTIMO MEDIO A TAGLIO ULTIMATE SHEAR LOAD	CARICO CARATTERISTICO A TRAZIONE CHARACTERISTIC TENSILE LOAD	CARICO CARATTERISTICO A TAGLIO CHARACTERISTIC SHEAR LOAD	CARICO AMMISSIBILE A TRAZIONE ADMISSIBLE TENSILE LOAD	CARICO AMMISSIBILE A TAGLIO ADMISSIBLE SHEAR LOAD
			$h_{ef MAX}$ [mm]	$N_{rum}$ [kN]	$V_{rum}$ [kN]	$N_{rk}$ [kN]	$V_{rk}$ [kN]	$N_{rec}$ [kN]	$V_{rec}$ [kN]
C20/25 Calcestruzzo fessurato Cracked Concrete Beton fissuré Gerissener Beton	A4-70	M12	240	59,0	35,4	54,2	29,5	22,5	13,5
	A4-70	M16	320	109,9	65,9	83,4	54,9	39,7	25,1
	A4-70	M20	400	171,5	102,9	143,0	85,7	65,5	39,2
	A4-70	M24	480	247,1	148,2	210,3	123,5	94,3	56,5







**Dati carico | Load data | Données de charge | Lastdaten**

<b>LEGGENDA</b>	<b>N<sub>rum</sub></b> [kN]	Carico ultimo medio a trazione > Average ultimate tension load > Charge maximum moyenne de traction Durchschnittliche maximale Zuglast
	<b>V<sub>rum</sub></b> [kN]	Carico ultimo medio a taglio > Average ultimate shear load > Charge maximum moyenne de cisaillement Durchschnittliche maximale Querlast
	<b>N<sub>rk</sub></b> [kN]	Carico caratteristico a trazione > Characteristic tension load > Charge caractéristique de traction Charakteristische Zuglast
	<b>V<sub>rk</sub></b> [kN]	Carico caratteristico a taglio > Characteristic shear load > Charge caractéristique de cisaillement Charakteristische Querlast
	<b>N<sub>rec</sub></b> [kN]	Carico ammissibile a trazione > Admissible tensile load > Charge admissible de traction > Zulässige Zuglast
	<b>V<sub>rec</sub></b> [kN]	Carico ammissibile a taglio > Admissible shear load > Charge admissible de cisaillement > Zulässige Querlast



> Carichi validi per singolo ancorante senza influenza di interasse e distanza dal bordo e  $h \geq 2h_f$  > 1kN = 100 Kg  
> Loads for single anchor with no influence of spacing and edge distance and with  $h \geq 2h_f$   
> Charges valables pour chaque ancrage sans influence d'interaxe et distance du bord et  $h \geq 2h_f$   
> Passende Ringe für den einzelnen Veranker, ohne Achsenabstandseinfluss und des Randabstands und  $h \geq 2h_f$

> Azione di taglio non diretta verso il bordo > Coefficiente di sicurezza globale incluso > Coefficiente lato carichi utilizzato = 1,4  
> Shear directed away from the edge > General safety factor included > Load increasing safety coefficient used = 1,4  
> Action de cisaillement pas dirigée vers le bord > Coefficient de sécurité générale inclu > Coefficient côté charge utilisé = 1,4  
> Queraktion nicht an den Rand gerichtet > Generelle Sicherheitskoeffizient inbegriffen > Verwendeter Lasterhöhungssicherheitskoeffizient = 1,4

Con foro allagato, riduzione del carico consigliato del 20%  
With flooded hole, reduction of the recommended load of 20%

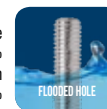

**MIN** Dati di carico con profondità effettiva ancoraggio MINIMA > Load data with MINIMUM effective anchorage depth  
Donnes de charge avec profondeur efficace d'ancrage MINIMALE > Lastdaten mit MINIMUM effektive Verankerungstiefe



EPOXY 21 MATERIALE MATERIAL	BARRA ROD	DIAMETRO BARRA ROD DIAMETER	PROFONDITÀ EFF. ANCORAGGIO EFFECTIVE ANCHORAGE DEPTH	CARICO ULTIMO MEDIO A TRAZIONE ULTIMATE TENSION LOAD	CARICO ULTIMO MEDIO A TAGLIO ULTIMATE SHEAR LOAD	CARICO CARATTERISTICO A TRAZIONE CHARACTERISTIC TENSILE LOAD	CARICO CARATTERISTICO A TAGLIO CHARACTERISTIC SHEAR LOAD	CARICO AMMISSIBILE A TRAZIONE ADMISSIBLE TENSILE LOAD	CARICO AMMISSIBILE A TAGLIO ADMISSIBLE SHEAR LOAD
				N <sub>rum</sub> [kN]	V <sub>rum</sub> [kN]	N <sub>rk</sub> [kN]	V <sub>rk</sub> [kN]	N <sub>rec</sub> [kN]	V <sub>rec</sub> [kN]
C20/25 Calcestruzzo non fessurato Non cracked Concrete Beton non fissuré Ungerissener Beton	A4-70	M8	60	21,2	15,3	13,5	12,8	6,4	5,8
	A4-70	M10	60	25,4	24,3	15,8	20,3	7,5	9,2
	A4-70	M12	70	39,4	35,4	22,2	29,5	10,5	13,5
	A4-70	M16	80	48,2	65,9	35,4	54,9	16,8	25,1
	A4-70	M20	90	57,6	102,9	41,5	83,0	19,7	39,2
	A4-70	M24	96	63,4	126,9	47,5	95,0	22,6	45,2
	A4-70	M27	110	77,8	155,7	58,2	116,5	27,7	55,4
	A4-70	M30	120	88,7	177,4	66,3	132,7	31,6	63,2

**MED** Dati di carico con profondità effettiva ancoraggio MEDIA > Load data with MEDIUM effective anchorage depth  
Donnes de charge avec profondeur efficace d'ancrage MOYENNE > Lastdaten mit MITTEL effektive Verankerungstiefe



EPOXY 21 MATERIALE MATERIAL	BARRA ROD	DIAMETRO BARRA ROD DIAMETER	PROFONDITÀ EFF. ANCORAGGIO EFFECTIVE ANCHORAGE DEPTH	CARICO ULTIMO MEDIO A TRAZIONE ULTIMATE TENSION LOAD	CARICO ULTIMO MEDIO A TAGLIO ULTIMATE SHEAR LOAD	CARICO CARATTERISTICO A TRAZIONE CHARACTERISTIC TENSILE LOAD	CARICO CARATTERISTICO A TAGLIO CHARACTERISTIC SHEAR LOAD	CARICO AMMISSIBILE A TRAZIONE ADMISSIBLE TENSILE LOAD	CARICO AMMISSIBILE A TAGLIO ADMISSIBLE SHEAR LOAD
				N <sub>rum</sub> [kN]	V <sub>rum</sub> [kN]	N <sub>rk</sub> [kN]	V <sub>rk</sub> [kN]	N <sub>rec</sub> [kN]	V <sub>rec</sub> [kN]
C20/25 Calcestruzzo non fessurato Non cracked Concrete Beton non fissuré Ungerissener Beton	A4-70	M8	80	25,6	15,3	18,0	12,8	8,6	5,8
	A4-70	M10	90	38,1	24,3	23,8	20,3	11,3	9,2
	A4-70	M12	110	59,0	35,4	34,9	29,5	16,6	13,5
	A4-70	M16	125	90,9	65,9	55,3	54,9	26,3	25,1
	A4-70	M20	170	146,8	102,9	78,4	85,7	37,3	39,2
	A4-70	M24	210	205,4	148,2	142,8	123,5	68,0	56,5
	A4-70	M27	240	250,9	192,7	182,2	160,6	86,7	73,5
	A4-70	M30	270	299,4	235,6	211,5	196,3	100,7	89,9

**MAX** Dati di carico con profondità effettiva ancoraggio MASSIMO > Load data with MAXIMUM effective anchorage depth  
Donnes de charge avec profondeur efficace d'ancrage MAXIMUM > Lastdaten mit MAXIMUM effektive Verankerungstiefe



EPOXY 21 MATERIALE MATERIAL	BARRA ROD	DIAMETRO BARRA ROD DIAMETER	PROFONDITÀ EFF. ANCORAGGIO EFFECTIVE ANCHORAGE DEPTH	CARICO ULTIMO MEDIO A TRAZIONE ULTIMATE TENSION LOAD	CARICO ULTIMO MEDIO A TAGLIO ULTIMATE SHEAR LOAD	CARICO CARATTERISTICO A TRAZIONE CHARACTERISTIC TENSILE LOAD	CARICO CARATTERISTICO A TAGLIO CHARACTERISTIC SHEAR LOAD	CARICO AMMISSIBILE A TRAZIONE ADMISSIBLE TENSILE LOAD	CARICO AMMISSIBILE A TAGLIO ADMISSIBLE SHEAR LOAD
				N <sub>rum</sub> [kN]	V <sub>rum</sub> [kN]	N <sub>rk</sub> [kN]	V <sub>rk</sub> [kN]	N <sub>rec</sub> [kN]	V <sub>rec</sub> [kN]
C20/25 Calcestruzzo non fessurato Non cracked Concrete Beton non fissuré Ungerissener Beton	A4-70	M8	160	25,6	15,3	25,6	12,8	9,7	5,8
	A4-70	M10	200	40,6	24,3	40,6	20,3	15,5	9,2
	A4-70	M12	240	59,0	35,4	59,0	29,5	22,5	13,5
	A4-70	M16	320	109,9	65,9	109,9	54,9	41,9	25,1
	A4-70	M20	400	171,5	102,9	171,5	85,7	65,5	39,2
	A4-70	M24	480	247,1	148,2	247,1	123,5	94,3	56,5
	A4-70	M27	540	321,3	192,7	321,3	160,6	122,7	73,5
	A4-70	M30	600	392,7	235,6	392,7	196,3	150,0	89,9



# SCHEDA TECNICA TECHNICAL DATA SHEET FICHE TECHNIQUE TECHNISCHES DATENBLATT

## Dati carico | Load data | Données de charge | Lastdaten

<b>D N E G L</b>	$N_{rum}$ [kN]	Carico ultimo medio a trazione > Average ultimate tension load > Charge maximum moyenne de traction Durchschnittliche maximale Zuglast
	$V_{rum}$ [kN]	Carico ultimo medio a taglio > Average ultimate shear load > Charge maximum moyenne de cisaillement Durchschnittliche maximale Querlast
	$N_{rk}$ [kN]	Carico caratteristico a trazione > Characteristic tension load > Charge caractéristique de traction Caratteristica Zuglast
	$V_{rk}$ [kN]	Carico caratteristico a taglio > Characteristic shear load > Charge caractéristique de cisaillement Caratteristica Querlast
	$N_{rec}$ [kN]	Carico ammissibile a trazione > Admissible tensile load > Charge admissible de traction > Zulässige Zuglast
	$V_{rec}$ [kN]	Carico ammissibile a taglio > Admissible shear load > Charge admissible de cisaillement > Zulässige Querlast

> Applicazioni in accordo alla teoria dell'ancoraggio  
> Application according to the anchors theory  
> Application en conformité avec la théorie de l'ancrage  
> Anwendung in Übereinstimmung mit der Verankerungstheorie

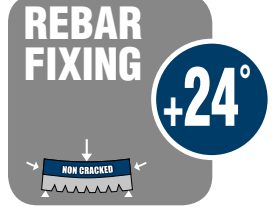

> Carichi validi per singolo ancorante senza influenza di interasse e distanza dal bordo e  $h \geq 2h_f$  > 1kN = 100 Kg  
> Loads for single anchor with no influence of spacing and edge distance and with  $h \geq 2h_f$  >  $\psi_{sua} = 1,0$   
> Charges valables pour chaque ancrage sans influence d'interaxe et distance du bord et  $h \geq 2h_f$   
> Passende Ringe für den einzelnen Veranker, ohne Achsenabstandseinfluss und des Randabstands und  $h \geq 2h_f$

> Azione di taglio non diretta verso il bordo > Coefficiente di sicurezza globale incluso > Coefficiente lato carichi utilizzato = 1,4  
> Shear directed away from the edge > General safety factor included > Load increasing safety coefficient used = 1,4  
> Action de cisaillement pas dirigée vers le bord > Coefficient de sécurité générale inclu > Coefficient côté charge utilisé = 1,4  
> Queraktion nicht an den Rand gerichtet > Generelle Sicherheitskoeffizient inbegriffen > Verwendeter Lasterhöhungssicherheitskoeffizient = 1,4

Con foro allagato, riduzione del carico consigliato del 20%  
With flooded hole, reduction of the recommended load of 20%



## MIN Dati di carico con profondità effettiva ancoraggio MINIMA > Load data with MINIMUM effective anchorage depth Donnes de charge avec profondeur efficace d'ancrage MINIMALE > Lastdaten mit MINIMALER effektiven Verankerungstiefe

MATERIALE MATERIAL	DIAMETRO BARRA ROD DIAMETER	PROFONDITÀ EFF. ANCORAGGIO EFFECTIVE ANCHORAGE DEPTH	CARICO ULTIMO MEDIO A TRAZIONE	CARICO ULTIMO MEDIO A TAGLIO	CARICO CARATTERISTICO A TRAZIONE	CARICO CARATTERISTICO A TAGLIO	CARICO AMMISSIBILE A TRAZIONE	CARICO AMMISSIBILE A TAGLIO
			ULTIMATE TENSION LOAD	ULTIMATE SHEAR LOAD	CHARACTERISTIC TENSILE LOAD	CHARACTERISTIC SHEAR LOAD	ADMISSIBLE TENSILE LOAD	ADMISSIBLE SHEAR LOAD
EPOXY 2	d [mm]	$h_{ef MIN}$ [mm]	$N_{rum}$ [kN]	$V_{rum}$ [kN]	$N_{rk}$ [kN]	$V_{rk}$ [kN]	$N_{rec}$ [kN]	$V_{rec}$ [kN]
C20/25 Calcestruzzo non fessurato Non cracked Concrete Beton non fissuré Ungerissener Beton	Ø8	60	24,3	16,2	19,8	13,5	9,4	7,7
	Ø10	60	30,4	25,4	23,4	21,2	11,1	12,1
	Ø12	70	39,5	36,6	29,5	30,5	14,0	17,4
	Ø14	80	48,3	49,8	36,1	41,5	17,2	23,7
	Ø16	80	48,3	65,1	36,1	54,2	17,2	31,0
	Ø20	90	57,6	101,7	43,1	84,8	20,5	41,0
	Ø25	100	67,5	135,0	50,5	101,0	24,0	48,1
	Ø28	112	80,0	160,0	59,8	119,7	28,5	57,0
	Ø32	128	97,7	195,5	73,1	146,2	34,8	69,6



## MED Dati di carico con profondità effettiva ancoraggio MEDIA > Load data with MEDIUM effective anchorage depth Donnes de charge avec profondeur efficace d'ancrage MOYENNE > Lastdaten mit MITTLERER effektiven Verankerungstiefe

MATERIALE MATERIAL	DIAMETRO BARRA ROD DIAMETER	PROFONDITÀ EFF. ANCORAGGIO EFFECTIVE ANCHORAGE DEPTH	CARICO ULTIMO MEDIO A TRAZIONE	CARICO ULTIMO MEDIO A TAGLIO	CARICO CARATTERISTICO A TRAZIONE	CARICO CARATTERISTICO A TAGLIO	CARICO AMMISSIBILE A TRAZIONE	CARICO AMMISSIBILE A TAGLIO
			ULTIMATE TENSION LOAD	ULTIMATE SHEAR LOAD	CHARACTERISTIC TENSILE LOAD	CHARACTERISTIC SHEAR LOAD	ADMISSIBLE TENSILE LOAD	ADMISSIBLE SHEAR LOAD
EPOXY 2	d [mm]	$h_{ef MED}$ [mm]	$N_{rum}$ [kN]	$V_{rum}$ [kN]	$N_{rk}$ [kN]	$V_{rk}$ [kN]	$N_{rec}$ [kN]	$V_{rec}$ [kN]
C20/25 Calcestruzzo non fessurato Non cracked Concrete Beton non fissuré Ungerissener Beton	Ø8	80	27,1	16,2	26,4	13,5	12,5	7,7
	Ø10	90	42,4	25,4	37,1	21,2	17,6	12,1
	Ø12	110	61,0	36,6	54,4	30,5	25,9	17,4
	Ø14	125	83,1	49,8	70,5	41,5	33,6	23,7
	Ø16	140	108,5	65,1	75,0	54,2	35,7	31,0
	Ø20	170	149,6	101,7	110,5	84,8	52,6	48,4
	Ø25	210	205,4	159,0	153,6	132,5	73,1	75,7
	Ø28	270	299,4	199,5	216,2	166,2	102,9	95,0
	Ø32	300	350,7	260,5	240,3	217,1	114,4	124,0



## MAX Dati di carico con profondità effettiva ancoraggio MASSIMO > Load data with MAXIMUM effective anchorage depth Donnes de charge avec profondeur efficace d'ancrage MAXIMUM > Lastdaten mit MAXIMALER effektiven Verankerungstiefe

MATERIALE MATERIAL	DIAMETRO BARRA ROD DIAMETER	PROFONDITÀ EFF. ANCORAGGIO EFFECTIVE ANCHORAGE DEPTH	CARICO ULTIMO MEDIO A TRAZIONE	CARICO ULTIMO MEDIO A TAGLIO	CARICO CARATTERISTICO A TRAZIONE	CARICO CARATTERISTICO A TAGLIO	CARICO AMMISSIBILE A TRAZIONE	CARICO AMMISSIBILE A TAGLIO
			ULTIMATE TENSION LOAD	ULTIMATE SHEAR LOAD	CHARACTERISTIC TENSILE LOAD	CHARACTERISTIC SHEAR LOAD	ADMISSIBLE TENSILE LOAD	ADMISSIBLE SHEAR LOAD
EPOXY 2	d [mm]	$h_{ef MAX}$ [mm]	$N_{rum}$ [kN]	$V_{rum}$ [kN]	$N_{rk}$ [kN]	$V_{rk}$ [kN]	$N_{rec}$ [kN]	$V_{rec}$ [kN]
C20/25 Calcestruzzo non fessurato Non cracked Concrete Beton non fissuré Ungerissener Beton	Ø8	160	27,1	16,2	27,1	13,5	12,9	7,7
	Ø10	200	42,4	25,4	42,4	21,2	20,2	12,1
	Ø12	240	61,0	36,6	61,0	30,5	29,0	17,4
	Ø14	280	83,1	49,8	83,1	41,5	39,5	23,7
	Ø16	320	108,5	65,1	108,5	54,2	51,7	31,0
	Ø20	400	169,6	101,7	169,6	84,8	80,7	48,4
	Ø25	500	265,0	159,0	265,0	132,5	126,2	75,7
	Ø28	560	332,5	199,5	332,5	166,2	158,3	95,0
	Ø32	640	434,2	260,5	434,2	217,1	206,8	124,0





**Dati carico | Load data | Données de charge | Lastdaten**

<b>D</b>	$N_{rum}$ [kN]	Carico ultimo medio a trazione > Average ultimate tension load > Charge maximum moyenne de traction Durchschnittliche maximale Zuglast
	$V_{rum}$ [kN]	Carico ultimo medio a taglio > Average ultimate shear load > Charge maximum moyenne de cisaillement Durchschnittliche maximale Querlast
<b>E</b>	$N_{rk}$ [kN]	Carico caratteristico a trazione > Characteristic tension load > Charge caracteristique de traction Caratteristica Zuglast
	$V_{rk}$ [kN]	Carico caratteristico a taglio > Characteristic shear load > Charge caracteristique de cisaillement Caratteristica Querlast
<b>L</b>	$N_{rec}$ [kN]	Carico ammissibile a trazione > Admissible tensile load > Charge admissible de traction > Zulässige Zuglast
	$V_{rec}$ [kN]	Carico ammissibile a taglio > Admissible shear load > Charge admissible de cisaillement > Zulässige Querlast

- > Applicazioni in accordo alla teoria dell'ancoraggio
- > Application according to the anchors theory
- > Application en conformité avec la théorie de l'ancrage
- > Anwendung in Übereinstimmung mit der Verankerungstheorie



> Carichi validi per singolo ancorante senza influenza di interasse e distanza dal bordo e  $h \geq 2h_f$  > 1kN = 100 Kg  
 > Loads for single anchor with no influence of spacing and edge distance and with  $h \geq 2h_f$   
 > Charges valables pour chaque ancrage sans influence d'interaxe et distance du bord et  $h \geq 2h_f$   
 > Passende Ringe für den einzelnen Veranker, ohne Achsenabstandseinfluss und des Randabstands und  $h \geq 2h_f$

- > Azione di taglio non diretta verso il bordo
- > Shear directed away from the edge
- > Action de cisaillement pas dirigée vers le bord
- > Queraktion nicht an den Rand gerichtet
- > Coefficiente di sicurezza globale incluso
- > General safety factor included
- > Coefficient de sécurité generale inclu
- > Generelle Sicherheitskoeffizient inbegriffen
- > Coefficiente lato carichi utilizzato = 1,4
- > Load increasing safety coefficient used = 1,4
- > Coefficient côté charge utilisé = 1,4
- > Verwendeter Lasterhöhungssicherheitskoeffizient = 1,4

Con foro allagato, riduzione del carico consigliato del 20%  
With flooded hole, reduction of the recommended load of 20%

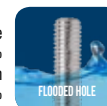

**MIN** Dati di carico con profondità effettiva ancoraggio MINIMA > Load data with MINIMUM effective anchorage depth  
Donnes de charge avec profondeur efficace d'ancrage MINIMALE > Lastdaten mit MINIMALER effektiven Verankerungstiefe

MATERIALE MATERIAL	DIAMETRO BARRA ROD DIAMETER	PROFONDITÀ EFF. ANCORAGGIO EFFECTIVE ANCHORAGE DEPTH	CARICO ULTIMO MEDIO A TRAZIONE	CARICO ULTIMO MEDIO A TAGLIO	CARICO CARATTERISTICO A TRAZIONE	CARICO CARATTERISTICO A TAGLIO	CARICO AMMISSIBILE A TRAZIONE	CARICO AMMISSIBILE A TAGLIO
			ULTIMATE TENSION LOAD	ULTIMATE SHEAR LOAD	CHARACTERISTIC TENSILE LOAD	CHARACTERISTIC SHEAR LOAD	ADMISSIBLE TENSILE LOAD	ADMISSIBLE SHEAR LOAD
EPOXY 21	d [mm]	$h_{ef MIN}$ [mm]	$N_{rum}$ [kN]	$V_{rum}$ [kN]	$N_{rk}$ [kN]	$V_{rk}$ [kN]	$N_{rec}$ [kN]	$V_{rec}$ [kN]
C20/25 Calcestruzzo non fessurato Non cracked Concrete Beton non fissuré Ungerissener Beton	Ø8	60	24,3	16,2	14,9	13,5	7,1	7,7
	Ø10	60	30,4	25,4	18,6	21,2	8,8	12,1
	Ø12	70	39,5	36,6	26,1	30,5	12,4	17,4
	Ø14	80	48,3	49,8	34,3	41,5	16,3	23,7
	Ø16	80	48,3	65,1	32,3	54,2	15,3	30,7
	Ø20	90	57,6	101,7	43,1	84,8	20,5	41,0
	Ø25	100	67,5	135,0	50,5	101,0	24,0	48,1
	Ø28	112	80,0	160,0	59,8	119,7	28,5	57,0
	Ø32	128	97,7	195,5	73,1	146,2	34,8	69,6



**MED** Dati di carico con profondità effettiva ancoraggio MEDIA > Load data with MEDIUM effective anchorage depth  
Donnes de charge avec profondeur efficace d'ancrage MOYENNE > Lastdaten mit MITTLERER effektiven Verankerungstiefe

MATERIALE MATERIAL	DIAMETRO BARRA ROD DIAMETER	PROFONDITÀ EFF. ANCORAGGIO EFFECTIVE ANCHORAGE DEPTH	CARICO ULTIMO MEDIO A TRAZIONE	CARICO ULTIMO MEDIO A TAGLIO	CARICO CARATTERISTICO A TRAZIONE	CARICO CARATTERISTICO A TAGLIO	CARICO AMMISSIBILE A TRAZIONE	CARICO AMMISSIBILE A TAGLIO
			ULTIMATE TENSION LOAD	ULTIMATE SHEAR LOAD	CHARACTERISTIC TENSILE LOAD	CHARACTERISTIC SHEAR LOAD	ADMISSIBLE TENSILE LOAD	ADMISSIBLE SHEAR LOAD
EPOXY 21	d [mm]	$h_{ef MED}$ [mm]	$N_{rum}$ [kN]	$V_{rum}$ [kN]	$N_{rk}$ [kN]	$V_{rk}$ [kN]	$N_{rec}$ [kN]	$V_{rec}$ [kN]
C20/25 Calcestruzzo non fessurato Non cracked Concrete Beton non fissuré Ungerissener Beton	Ø8	80	27,1	16,2	19,8	13,5	9,4	7,7
	Ø10	90	42,4	25,4	27,9	21,2	13,3	12,1
	Ø12	110	61,0	36,6	41,0	30,5	19,5	17,4
	Ø14	125	83,1	49,8	53,6	41,5	25,5	23,7
	Ø16	140	108,5	65,1	56,5	54,2	26,9	31,0
	Ø20	170	149,6	101,7	83,3	84,8	39,6	48,4
	Ø25	210	205,4	159,0	123,7	132,5	58,9	75,7
	Ø28	270	299,4	199,5	162,9	166,2	77,6	95,0
	Ø32	300	350,7	260,5	181,1	217,1	86,2	124,0



**MAX** Dati di carico con profondità effettiva ancoraggio MASSIMO > Load data with MAXIMUM effective anchorage depth  
Donnes de charge avec profondeur efficace d'ancrage MAXIMUM > Lastdaten mit MAXIMALER effektiven Verankerungstiefe

MATERIALE MATERIAL	DIAMETRO BARRA ROD DIAMETER	PROFONDITÀ EFF. ANCORAGGIO EFFECTIVE ANCHORAGE DEPTH	CARICO ULTIMO MEDIO A TRAZIONE	CARICO ULTIMO MEDIO A TAGLIO	CARICO CARATTERISTICO A TRAZIONE	CARICO CARATTERISTICO A TAGLIO	CARICO AMMISSIBILE A TRAZIONE	CARICO AMMISSIBILE A TAGLIO
			ULTIMATE TENSION LOAD	ULTIMATE SHEAR LOAD	CHARACTERISTIC TENSILE LOAD	CHARACTERISTIC SHEAR LOAD	ADMISSIBLE TENSILE LOAD	ADMISSIBLE SHEAR LOAD
EPOXY 21	d [mm]	$h_{ef MAX}$ [mm]	$N_{rum}$ [kN]	$V_{rum}$ [kN]	$N_{rk}$ [kN]	$V_{rk}$ [kN]	$N_{rec}$ [kN]	$V_{rec}$ [kN]
C20/25 Calcestruzzo non fessurato Non cracked Concrete Beton non fissuré Ungerissener Beton	Ø8	160	27,1	16,2	27,1	13,5	12,9	7,7
	Ø10	200	42,4	25,4	42,4	21,2	20,2	12,1
	Ø12	240	61,0	36,6	61,0	30,5	29,0	17,4
	Ø14	280	83,1	49,8	83,1	41,5	39,5	23,7
	Ø16	320	108,5	65,1	108,5	54,2	51,7	31,0
	Ø20	400	169,6	101,7	169,6	84,8	80,7	48,4
	Ø25	500	265,0	159,0	265,0	132,5	126,2	75,7
	Ø28	560	332,5	199,5	332,5	166,2	158,3	95,0
	Ø32	640	434,2	260,5	386,3	217,1	184,0	124,0





**SCHEDA TECNICA  
TECHNICAL DATA SHEET  
FICHE TECHNIQUE  
TECHNISCHES DATENBLATT**

**CONNESSIONI POST-INSTALLATE DI BARRE AD ADERENZA MIGLIORATA  
POST-INSTALLED REBAR CONNECTIONS  
SCÉLLEMENT D'ARMATURES RAPPORTÉES (FERS À BÉTON)  
NACHTRÄGLICHE BEWEHRUNGSANSCHÜSSE**



Perforazione con trapano > Hammer drilled holes  
Perçage avec perforateur > Durchbohrung mit Bohrmaschine



MATERIALE MATERIAL	TIPOLOGIA DI BARRA TYPE OF ROD	DIAMETRO BARRA ROD DIAMETER	TENSIONE DI ADERENZA fbd [N/mm²] > BOND RESISTANCE fbd [N/mm²] Buone condizioni di aderenza > Good bond condition								
			d [mm]	C 12/15	C 16/20	C 20/25	C 25/30	C 30/37	C 35/45	C 40/50	C 45/55
<b>Calcestruzzo</b> <b>Concrete</b> <b>Beton</b> <b>Beton</b>  ETAG 001 TR023 ETA-11/0345  (*) Rebar = B450C; BST 500	Rebar (*)	Ø 8	1,6	2,0	2,3	2,7	3,0	3,4	3,7	4,0	4,3
	Rebar (*)	Ø 10	1,6	2,0	2,3	2,7	3,0	3,4	3,7	4,0	4,3
	Rebar (*)	Ø 12	1,6	2,0	2,3	2,7	3,0	3,4	3,7	4,0	4,3
	Rebar (*)	Ø 14	1,6	2,0	2,3	2,7	3,0	3,4	3,7	4,0	4,3
	Rebar (*)	Ø 16	1,6	2,0	2,3	2,7	3,0	3,4	3,7	4,0	4,3
	Rebar (*)	Ø 20	1,6	2,0	2,3	2,7	3,0	3,4	3,7	4,0	4,3
	Rebar (*)	Ø 25	1,6	2,0	2,3	2,7	3,0	3,4	3,7	4,0	4,3
	Rebar (*)	Ø 28	1,6	2,0	2,3	2,7	3,0	3,4	3,7	4,0	4,3
	Rebar (*)	Ø 32	1,6	2,0	2,3	2,7	3,0	3,4	3,7	4,0	4,0

Dati di tensione di aderenza fbd validi per tutte le lunghezze di ancoraggio > Design value of bond strength fbd suitable for all anchorage lengths  
Données de tension et d'adhérence fbd valables pour toutes les longueurs d'ancrage > Bemessungswert der Verbundspannung fbd Gültig für alle Ankerungslänge

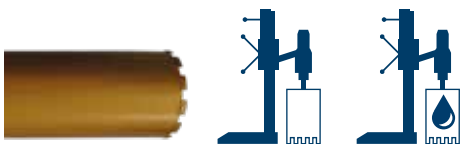

Perforazione con carotatrice (secco/umido) > Drilling with diamond core drill (dry/wet)  
Perçage avec machine pour carottage (sec/humide) > Durchbohrung mit Kernbohrmotor (nass/trocken)



MATERIALE MATERIAL	TIPOLOGIA DI BARRA TYPE OF ROD	DIAMETRO BARRA ROD DIAMETER	TENSIONE DI ADERENZA fbd [N/mm²] > BOND RESISTANCE fbd [N/mm²] Buone condizioni di aderenza > Good bond condition								
			d [mm]	C 12/15	C 16/20	C 20/25	C 25/30	C 30/37	C 35/45	C 40/50	C 45/55
<b>Calcestruzzo</b> <b>Concrete</b> <b>Beton</b> <b>Beton</b>  ETAG 001 TR023 ETA-11/0345  (*) Rebar = B450C; BST 500	Rebar (*)	Ø 8	1,6	2,0	2,3	2,7	3,0	3,4	3,7	4,0	4,3
	Rebar (*)	Ø 10	1,6	2,0	2,3	2,7	3,0	3,4	3,7	4,0	4,3
	Rebar (*)	Ø 12	1,6	2,0	2,3	2,7	3,0	3,4	3,7	4,0	4,3
	Rebar (*)	Ø 14	1,6	2,0	2,3	2,7	3,0	3,4	3,7	4,0	4,3
	Rebar (*)	Ø 16	1,6	2,0	2,3	2,7	3,0	3,4	3,7	4,0	4,3
	Rebar (*)	Ø 20	1,6	2,0	2,3	2,7	3,0	3,4	3,7	4,0	4,3
	Rebar (*)	Ø 25	1,6	2,0	2,3	2,7	3,0	3,4	3,7	4,0	4,3
	Rebar (*)	Ø 28	1,6	2,0	2,3	2,7	3,0	3,4	3,7	3,7	3,7
	Rebar (*)	Ø 32	1,6	2,0	2,3	2,7	3,0	3,0	3,0	3,0	3,0

Dati di tensione di aderenza fbd validi per tutte le lunghezze di ancoraggio > Design value of bond strength fbd suitable for all anchorage lengths  
Données de tension et d'adhérence fbd valables pour toutes les longueurs d'ancrage > Bemessungswert der Verbundspannung fbd Gültig für alle Ankerungslänge



**Dati carico | Load data | Données de charge | Lastdaten**



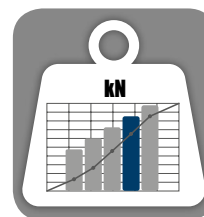

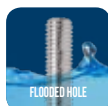

<b>LEGEND</b>	$N_{Rum}$ [kN]	Carico ultimo medio a trazione > Average ultimate tension load > Charge maximum moyenne de traction Durchschnittliche maximale Zuglast
	$V_{Rum}$ [kN]	Carico ultimo medio a taglio > Average ultimate shear load > Charge maximum moyenne de cisaillement Durchschnittliche maximale Querlast
	$N_{rec}$ [kN]	Carico ammissibile a trazione > Admissible tensile load > Charge admissible de traction > Zulässige Zuglast
	$V_{rec}$ [kN]	Carico ammissibile a taglio > Admissible shear load > Charge admissible de cisaillement > Zulässige Querlast



- > Carichi validi per singolo ancorante senza influenza di interasse e distanza dal bordo e  $h \geq 2h_{ef}$
  - > Loads for single anchor with no influence of spacing and edge distance and with  $h \geq 2h_{ef}$
  - > Charges valables pour chaque ancrage sans influence d'interaxe et distance du bord et  $h \geq 2h_{ef}$
  - > Passende Ringe für den einzelnen Veranker, ohne Achsenabstandseinfluss und des Randabstands und  $h \geq 2h_{ef}$
- > 1kN = 100 Kg
- > Azione di taglio non diretta verso il bordo
  - > Shear directed away from the edge
  - > Action de cisaillement pas dirigée vers le bord
  - > Queraktion nicht an den Rand gerichtet
- > Coefficiente di sicurezza globale incluso
  - > General safety factor included
  - > Coefficient de sécurité generale inclu
  - > Generelle Sicherheitskoeffizient inbegriffen
- > Coefficiente lato carichi utilizzato = 1,4
  - > Load increasing safety coefficient used = 1,4
  - > Coefficient côté charge utilisé = 1,4
  - > Verwendeter Lasterhöhungssicherheitskoeffizient = 1,4



Con foro allagato, riduzione del carico consigliato del 20%  
With flooded hole, reduction of the recommended load of 20%  
Avec trou inondé, c'est nécessaire réduire de 20% la charge conseillée  
Mit Wasser gefüllten Bohrlöcher ist eine Ermäßigung der Projektlast von 20% notwendig

MATERIALE MATERIAL	TIPOLOGIA DI BARRA TYPE OF ROD	DIAMETRO BARRA ROD DIAMETER	CARICO ULTIMO MEDIO A TRAZIONE ULTIMATE TENSION LOAD	CARICO ULTIMO MEDIO A TAGLIO ULTIMATE SHEAR LOAD	CARICO AMMISSIBILE A TRAZIONE ADMISSIBLE TENSILE LOAD	CARICO AMMISSIBILE A TAGLIO ADMISSIBLE SHEAR LOAD
			$N_{Rum}$ [kN]	$V_{Rum}$ [kN]	$N_{rec}$ [kN]	$V_{rec}$ [kN]
<b>Mattone pieno</b> Solid Brick Brique pleine Vollmauerwerk    <b>≥ 4.6 / A2-70 / A4-70</b>  	$\geq 4.6$ A2-70 A4 -70	M8	  > Dati di carico raccomandati per applicazioni su materiali base di medie caratteristiche meccaniche. Vista la varietà dei substrati in muratura e/o legno per applicazioni su supporti differenti da quelli considerati, i valori di carico dovranno essere ricavati tramite opportune prove in situ.  > Recommended loads for applications on base materials with medium strength characteristics. For different masonry and/or wood base materials, load values must be obtained with in situ tests.	  > Per valori a taglio riferirsi alle istruzioni CNR-DT 206/2007 (7.10.2.3)  > For shear loads refer to CNR-DT 206/2007 (7.10.2.3)	2,0	3,0
	$\geq 4.6$ A2-70 A4 -70	M10			2,6	3,4
	$\geq 4.6$ A2-70 A4 -70	M12			2,8	3,9
	$\geq 4.6$ A2-70 A4 -70	M16			4,0	4,2
<b>Legno lamellare</b> Laminated Timber Timber Holz    <b>≥ 4.6 / A2-70 / A4-70</b>  	$\geq 4.6$ A2-70 A4 -70	M8	3,2			
	$\geq 4.6$ A2-70 A4 -70	M10	4,2			
	$\geq 4.6$ A2-70 A4 -70	M12	6,1			
	$\geq 4.6$ A2-70 A4 -70	M16	10,7			



# INSTALLATION

PROCEDURA DI INSTALLAZIONE  
INSTALLATION PROCEDURE  
PROCÉDURE D'INSTALLATION  
INSTALLATIONSVERFAHREN

## 01 PULIZIA | CLEANING | NETTOYAGE | REINIGUNG

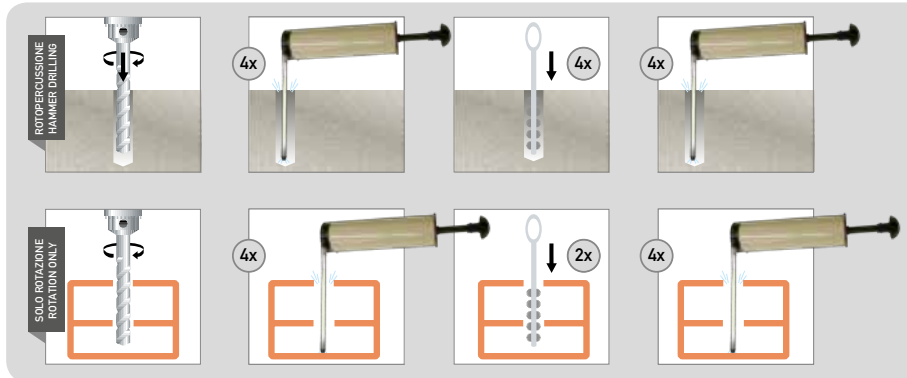

SDS-HDB (pag. 203)

Se utilizzata non necessita di pompa soffiante/aria compressa per la rimozione della polvere dal foro  
If used no need to use blower pump/compressed air to remove the dust from the hole

Eseguire il foro controllandone la perpendicolarità. Soffiare il foro con apposita pompa soffiante (o aria compressa), eseguire operazione di pulizia della superficie laterale del foro con apposito scovolino metallico, soffiare nuovamente il foro fino a che non fuoriesca più polvere e/o altro materiale residuo. Si raccomanda un'attenta pulizia della superficie laterale del foro con scovolino metallico.

Drill the hole and check it's perpendicularity. Blow the hole with an appropriate pump blower (or compression air), clean the lateral surface of the hole with an appropriate steel brush, blow again in the hole until there is no dust and/or any residual material inside. We strongly recommend use of the steel brush to clean hole sides.

Réaliser le trou en en contrôlant la perpendicolarité. Souffler dans le trou avec la pompe soufflante prévue (ou de l'air comprimé), effectuer l'opération de nettoyage de la surface latérale du trou avec un écouvillon métallique, souffler à nouveau dans le trou jusqu'à ce qu'il n'en sorte plus de poussière et/ou d'autres matières résiduelles. Nous recommandons l'utilisation d'écouvillon métallique pour le nettoyage de la surface latérale du trou.

Stellen Sie die Bohrlöcherung unter Kontrolle der Rechtwinkligkeit her. Blasen Sie die Bohrlöcherung mit einer entsprechenden Pumpe (oder Druckluft) durch, nehmen Sie eine Reinigung der seitlichen Oberflächen der Bohrlöcherung mit einer Bürste von Metall vor, blasen Sie die Bohrlöcherung erneut durch, bis kein Pulver und / oder andere Materialrückstände mehr austreten. Insbesondere ist die Benutzung der Metallbürste für die Reinigung der seitlichen Oberfläche der Bohrlöcherung notwendig.

## 02 APERTURA | OPENING | OUVERTURE | ÖFFNUNG

BCR 300  
BCR 165



Svitare il tappo, avvitare il miscelatore e inserire la cartuccia nella pompa usando protezioni per mani e viso. Nei formati 300 ml e 165 ml svitare il tappo, estrarre la clip metallica secondo le seguenti operazioni: 1) Inserire il miscelatore nell'asola dell'estrattore in plastica. 2) Tirare l'estrattore per sfilare la clip metallica di chiusura del sacchetto. Dopodiché avvitare il miscelatore, inserire la cartuccia nella pompa usando protezioni per mani e viso.

Unscrew the front cup, screw on the mixer and insert the cartridge in the gun. Use protections for hands and face. With the size 300 ml and 165 ml, unscrew the front cup, pull-out the steel closing clip according to the following operations: 1) Insert the mixer in the eye of the plastic extractor. 2) Pull the extractor to unhook the steel closing clip of the foil. After that, screw on the mixer and insert the cartridge in the gun. Use protections for hands and face.

Dévisser le bouchon, visser le mélangeur et insérer la cartouche dans la pompe en utilisant les protections pour les mains et le visage. Pour les formats 300 ml et 165 ml, dévisser le bouchon, extraire le clip métallique selon les opérations suivantes: 1) Insérer le mélangeur dans la fente de l'extracteur en plastique. 2) Tirer l'extracteur pour défaire le clip métallique de fermeture du sachet. Après cela, visser le mélangeur, insérer la cartouche dans la pompe en utilisant les protections pour les mains et le visage.

Lösen Sie den Verschluss, schrauben Sie den Mischer an und bringen Sie den Einsatz in der Pumpe unter Verwendung von Schutzmitteln für Hände und Gesicht an. Lösen Sie bei den Formaten zu 300 ml und 165 ml den Verschluss und ziehen Sie die Metallklemme entsprechend folgender Vorgehensweise heraus: 1) Fügen Sie den Mischer in das Langloch der Ausziehvorrichtung aus Kunststoff ein. 2) Ziehen Sie die Ausziehvorrichtung heraus, um die Metallklemme zum Verschließen des Beutels zu entfernen. Schrauben Sie dann den Mischer fest und fügen Sie den Einsatz in die Pumpe unter Verwendung von Schutzmitteln für Hände und Gesicht ein.

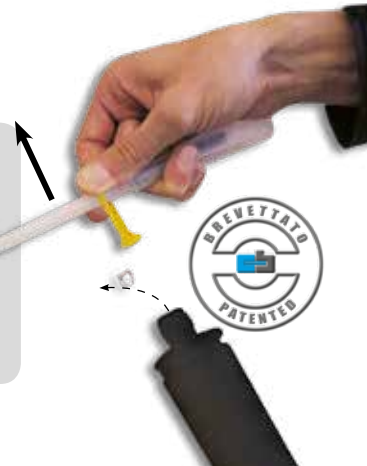

BCR 900 / BCR 825 / BCR 470 / BCR 400 / BCR 345 / BCR 265

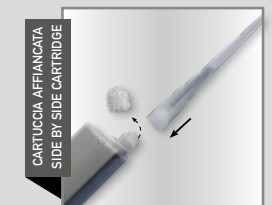
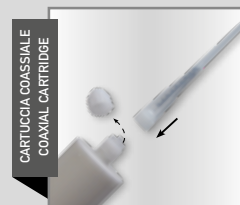



## 03 PREPARAZIONE DELLA CARTUCCIA | CARTRIDGE PREPARATION PREPARATION DE LA CARTOUCHE | KARTUSCHE VORBEREITUNG



Utilizzare dispenser appropriato  
Use the correct dispenser  
Utiliser un distributeur approprié  
Verwenden Sie einen geeigneten Spender

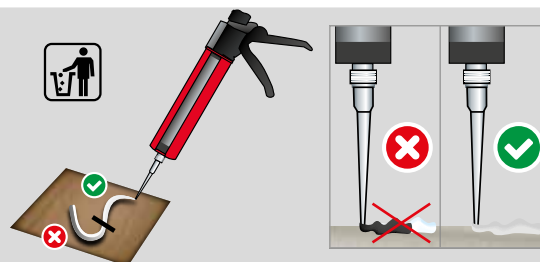

Estrudere una prima parte del prodotto assicurandosi che: 1) Attraverso il mixer (trasparente) il flusso di prodotto sia composto dalla parte A (colore bianco) e dalla parte B (colore nero). 2) I due componenti si siano completamente miscelati. La completa miscelazione è raggiunta quando dal miscelatore il prodotto, ottenuto dall'unione dei due componenti, fuoriesce con colore uniforme. Solo allora la cartuccia è pronta per l'uso.

Before starting to use the cartridge, eject a first part of the product, being sure that: 1) Through the mixer (transparent) see that the flux of product is composed of the part A (white colour) and of part B (black colour). 2) The two components are completely mixed. The complete mixing is reached only after that the product, obtained by mixing the two component, comes out from the mixer with an uniform colour. Now the cartridge is ready to be used.

Extruder une première partie du produit en s'assurant que: 1) Travers le mélangeur (transparent) le flux de produit est composé par les composants A (blanc) et B (noir). 2) Les deux composants soient complètement mélangés. Le mélange complet est atteint quand le produit obtenu par l'union des deux composants sort du mélangeur avec une couleur uniforme. Alors seulement, la cartouche est prête à l'emploi.

Ziehen Sie einen ersten Teil des Produktes heraus und prüfen Sie dass: 1) Durch den Mischer (transparent) ist der Fluss des Produktes aus Teil A (weiße Farbe) und Teil B (schwarze Farbe) zusammengesetzt. 2) Die zwei Teilen werden völlig gemischt. Die komplette Mischung erfolgt als vom Mischer das Produkt, sich ergebend von den zwei Teilen, mit gleichmäßiger Farbe entweicht. Da ist die Kartusche fertig für die Anwendung.

## 04 INIEZIONE | INJECTION | INJECTION | INJEKTION

Per consumi resina vedere pag. 71  
For resin quantity consumption see pag. 71  
Pour la consommation de résine, voir pag. 71  
Für Harzkonsum siehe S. 71

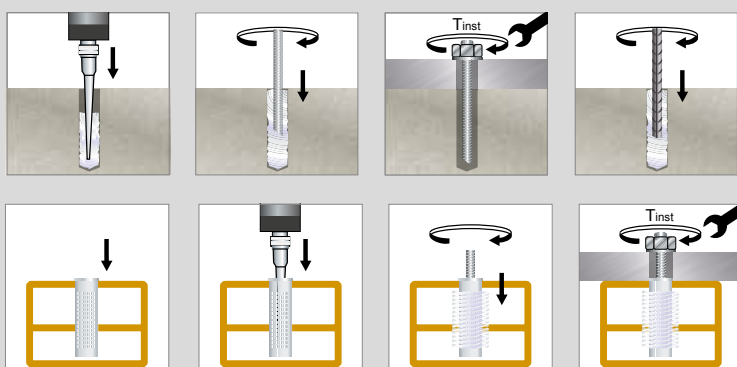

1) Estrudere la resina nel foro fino a riempirlo per 2/3. In caso di materiale forato inserire la gabbietta di plastica e poi estrarre nella gabbietta. 2) Prima di inserire la barra verificare che la superficie della stessa sia asciutta, priva di olio ed altri agenti contaminanti. Inserire la barra con un movimento rotatorio per la fuoriuscita delle bolle d'aria. 3) Per l'installazione della barra e la successiva messa in carico rispettare i relativi tempi di posa specificati sia nella scheda tecnica che sull'etichetta del prodotto. 4) Prima della messa in carico verificare l'indurimento del prodotto. 5) La cartuccia può essere riutilizzata successivamente sostituendo il mixer con uno nuovo. Ricordarsi sempre di estrarre una parte del prodotto vedi punto 3.

1) Inject resin into the hole up to fill it 2/3rds. In hollow bricks use the plastic sleeve and inject the resin inside. 2) Before insert the rod, verify that the element is dry and free oil and other contaminants. Insert threaded stud turning back and forth to avoid presence of air in the fitted hole. 3) For the installation and the following anchor load phase, respect the open time and curing time detailed in the technical data sheet and in the label of the product. 4) Before to load the anchor, check the hardened of the product. 5) The cartridge can be used again screwing the cup and replacing the mixer. Remember to eject a first part of the product, see point 3.

1) Extruder la résine dans le trou jusqu'à le remplir aux 2/3. En cas de matériel troué, insérer la forme en plastique et ensuite extruder dans la forme. 2) Avant d'insérer la barre, vérifier que la surface est sèche, sans rest de huile ou d'autres agents contaminants. Insérer la barre avec un mouvement de rotation pour faire sortir les bulles d'air. 3) Pour l'installation de la barre et le suivant chargement de l'ancrage, respecter les temps de prise indiqués sur la fiche technique et sur la cartouche. 4) Avant de charger l'ancrage, vérifier le durcissement du produit. 5) La cartouche peut être réutilisée par la suite en remplaçant le mixer par un nouveau. Se rappeler de toujours extruder une partie du produit voir point 3.

1) Pressen Sie das Harz in das Bohrloch bis diese zu 2/3 gefüllt ist. Bei Lochmaterialien muss der Siebhülse eingefügt und dann in die Hülse gepresst werden. 2) Vor dem Einstecken des Gewindestabes prüfen dass seine Fläche trocken, ohne Öl und andere verunreinigende Wirkstoffe ist. Fügen Sie den Stab mit einer Drehbewegung ein, um die Luftblasen austreten zu lassen. 3) Warten Sie die Aushärtezeit und Verladungszeit ab, die im technischen Datenblatt und auf dem Etikett des Produktes angegeben sind. 4) Vor der Verladung überprüfen dass das Produkt verhärtet ist. 5) Der Einsatz kann später wiederverwendet werden, indem der Mischer durch einen neuen ersetzt wird. Vergessen Sie nicht, immer einen Teil des Produktes herauszupressen, siehe Punkt 3.





# SCHEDA TECNICA TECHNICAL DATA SHEET FICHE TECHNIQUE TECHNISCHES DATENBLATT

www.bossong.com

**NOTA.** Dati tecnici, di installazione e di carico possono essere oggetto di revisione. Per una versione aggiornata consultare le schede tecniche sul sito [www.bossong.com](http://www.bossong.com) o contattare il nostro Ufficio Tecnico.

**WARNING.** Installation and loads technical data can be modified by us. For update technical data sheet see [www.bossong.com](http://www.bossong.com) or be in contact with our Technical Office.

**NOTE.** Données techniques, d'installation et de charge peuvent être objet de révision. Pour une version mise à jour, consulter les fiches techniques dans le site internet [www.bossong.com](http://www.bossong.com) ou contacter notre Bureau Technique.

**ANMERKUNG.** Technische Daten, Installationsangaben und Lastdaten können modifiziert werden. Für die aktualisierte Version sind die technischen Blätter auf der Webseite [www.bossong.com](http://www.bossong.com) nachzuschauen, oder unser Technisches Büro soll konsultiert werden.

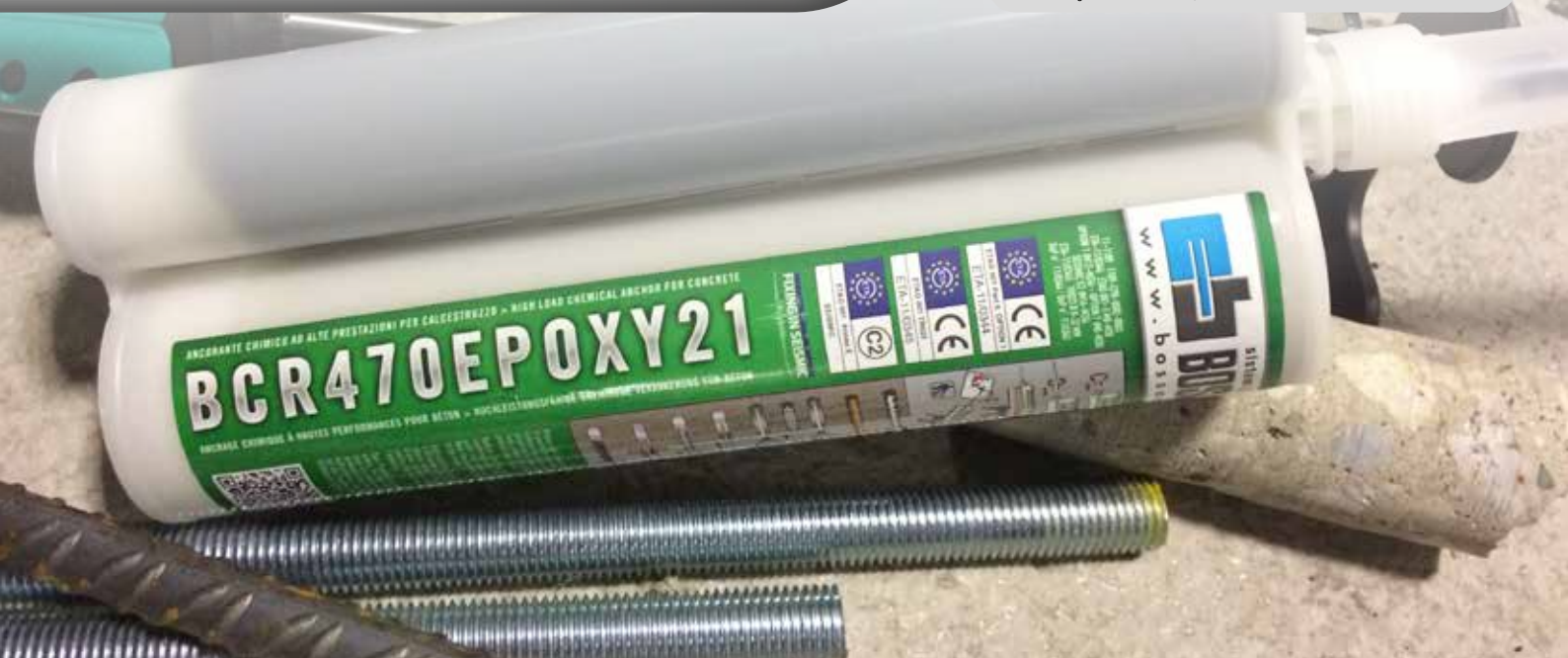

## HIGH LOAD CHEMICAL ANCHOR FOR CONCRETE

Ancorante chimico ad alte prestazioni per calcestruzzo > Ancrage chimique à hautes performances pour béton > Hochleistungsfähige chemische Verankerung für beton

